

# ROMMEL IN THE DESERT

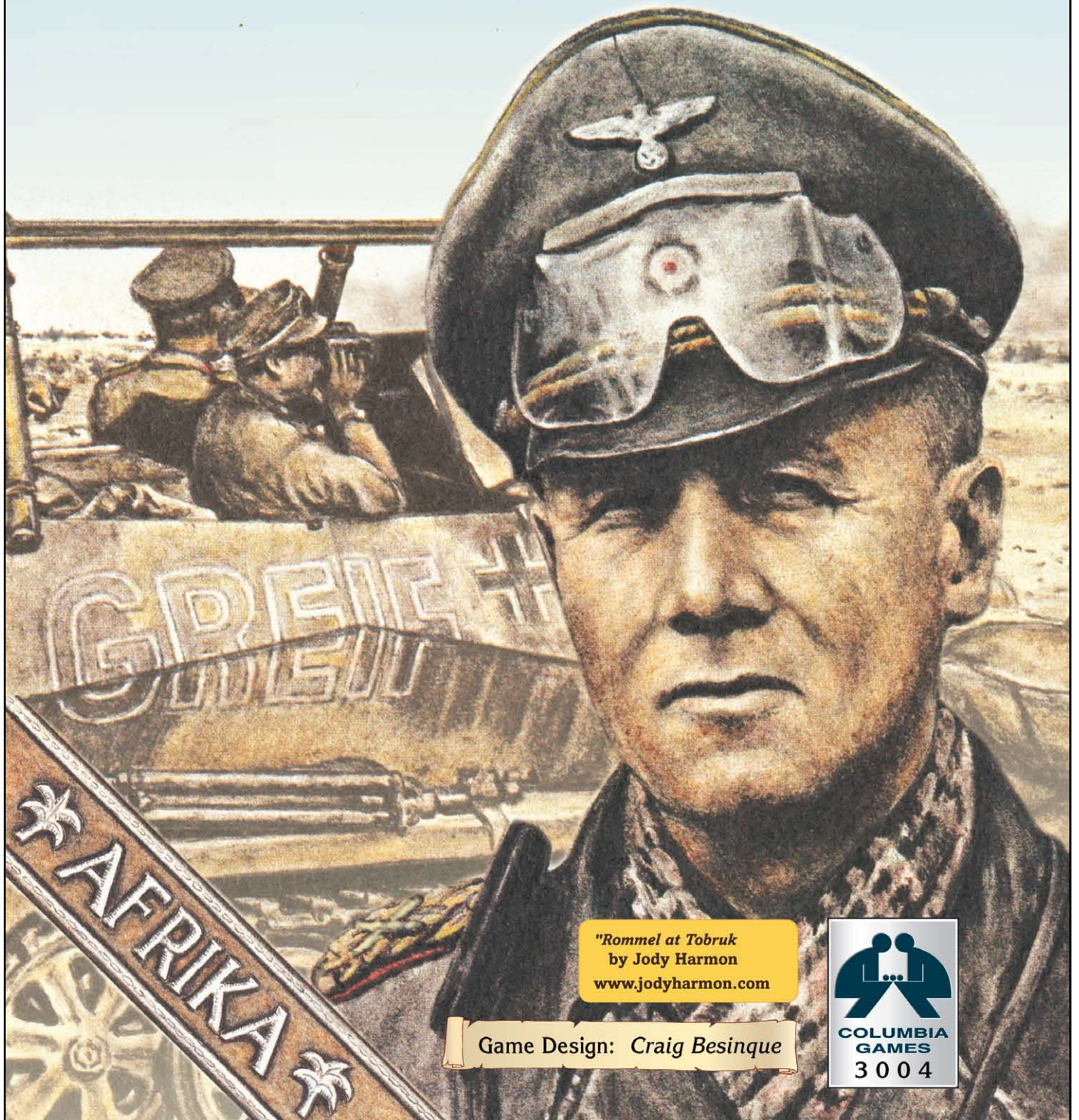

"Rommel at Tobruk  
by Jody Harmon  
[www.jodyharmon.com](http://www.jodyharmon.com)

Game Design: *Craig Besinque*



# ROMMEL IN THE DESERT

## TABLE OF CONTENTS

- 1.0 THE MAP
- 2.0 UNITS
- 3.0 SEQUENCE OF PLAY
- 4.0 TURN OPTIONS
- 5.0 GROUP MOVEMENT
- 6.0 UNIT MOVEMENT
- 7.0 ENGAGEMENT
- 8.0 BATTLES
- 9.0 COMBAT
- 10.0 RETREATS
- 11.0 DISRUPTION
- 12.0 SUPPLY
- 13.0 FORTRESSES
- 14.0 MINEFIELDS
- 15.0 OASES
- 16.0 BUILDUP
- 17.0 VICTORY
- 18.0 SCENARIOS
- 19.0 DEMO GAME
- 20.0 STRATEGY NOTES
- 21.0 DESIGN NOTES

## GAME DESIGN

*Craig Besinque*

## CO-DEVELOPER

*Ron Hodwitz*

## ASSISTANCE

*Gary Chappell*

*Dave Blizzard*

*Brion Emde*

## GRAPHICS

*Grant Dalgliesh*

*Tom Dalgliesh*

*Chris Moeller*

©1984-2004 Columbia Games Inc.

Visit [www.columbiagames.com](http://www.columbiagames.com) for updates on this game.

# ROMMEL IN THE DESERT™

## INTRODUCTION

*Rommel in the Desert* is a game of strategy for two players based on the North African Campaign of World War II. One player commands the Allied (British and Commonwealth) forces, and the other commands the Axis (German and Italian) forces.

Game Scenarios provided include: the 1941 and 1942 Campaigns, the 1940 "Italian" Campaign, and several shorter scenarios. The 1941 and 1942 campaigns can also be combined into the full "campaign game".

The game is played in alternating Player Turns, with monthly Buildup interludes (for Reinforcements, Resupply, etc.).

The object of the game is to hold Tobruk **and** its environs, or preserve a superior army if this area remains contested. Capturing the enemy Base wins the game **immediately**.

## THE MAPBOARD

The mapboard depicts the area of Libya and Egypt where the historical campaign was mainly fought. The map is divided into hexagons, or "hexes", to determine position and movement.

Except at *Gaps*, Ridges and Marshes are impassable. Mountain Hexsides are passable only on roads. Fortress symbols have numbers inside showing their *Port Capacities*.

## THE UNITS

Wooden block *units* represent Allied brigades, German regiments/battalions, and Italian divisions, plus some composite support units.

A die-cut, adhesive label showing the unit's type and strength must be attached to each block. Put dark green (German) and light green (Italians) labels on the **black** blocks, and the tan labels (Allies) on the **red** blocks.

Units in play normally stand upright, with labels facing the owning player. This provides simple yet elegant "fog of war" in that players cannot see the type or strength of opposing units.

Unit type (armor, recon, etc.) is shown by its central symbol. A unit's *type* determines its firepower and movement rate.

The large numbers surrounding the unit symbol show unit strength, called *Combat Value* ("CV"). A unit's current strength is the number along the **top edge** when standing upright.

Units generally begin a Scenario at their maximum CV level, but can be reduced by combat and also rebuilt. A unit reduced below its lowest CV is permanently eliminated from play.

## SUPPLY CARDS

Players start a game with a given number of Supply Cards and receive additional cards every month. Two-thirds of the cards provided are "real" Supply Cards; 1/3rd are "dummy" Supply Cards. Real Supply Cards are expended to "buy" various defined combinations of movement and combat, called *Turn Options*. Dummies have no value beyond creating doubt.

## SEQUENCE OF PLAY

A *Month* of play consists of Buildup, Initiative, and a variable number of alternating Player-Turns.

During *Buildup*, players strengthen and rearrange existing units and receive new units and Supply Cards.

Then players take alternating *Player-Turns*, the Axis player generally going first. The Active Player secretly selects a *Turn Option* by playing some Supply Cards face down (and dummy Supply can be included for bluffing reasons). He then executes one or more Movement and Combat phases as that Turn Option allows. Players may elect to *Pass* on their turn in order to conserve Supply.

The number of Player-Turns in a Month is variable: play continues as long as players continue to expend Supply Cards. When both players Pass consecutively, that Month of play ends, and a new Month begins.

## Rulebook Conventions

This rulebook is formatted so that the sidebar (this column) contains definitions, examples, suggestions, and historical commentary to help you understand and enjoy this game.

Terms specifically defined for gameplay purposes are Capitalized and are defined where shown in *italics*. **Bold text is generally used for emphasis.**

## The Arena

The map depicts an area of North Africa stretching some five hundred miles from Alexandria to El Agheila. This region is primarily a rocky and barren plateau (roughly 300-500' high) which drops sharply to sea-level in a series of rugged escarpments near the coastline. The narrow coastal shelf contains most settlements and roads, notably the towns of Benghazi, Tobruk, and Bardia. There is a hilly, wooded, cultivable area between Benghazi and Derna (Jebel el Akhdar) with peaks up to 2500'. Southward lies a desert wasteland, largely waterless except for the oases of Jalo, Jarabub, and Siwa. The eastern desert boundary is the Qattara Depression, a below sea-level salt marsh impassable to modern vehicles and armies; the narrow gap between the depression and the sea at El Alamein is the sole gateway east to Alexandria, Cairo, and the Suez Canal. Within this isolated, but well defined arena, the dramatic desert campaign was fought.

## Interpreting the map

Borders and terrain features are meant to follow hexsides though they are drawn with some artistic license.

# ROMMEL IN THE DESERT™

## 1.0 THE MAP

The Axis player sits on the South edge of the map while the Allied player sits on the North edge.

## 1.1 HEXES

The mapboard is divided into hexagons or *hexes* to determine unit location and movement. A *Hexside* is the boundary between two hexes.

Hexes can be identified by the towns or fortresses they contain, or by a direction and distance from one (see the compass rose printed on the map). For example, "Msus E1" is one hex east of Msus.

## 1.2 HEX CONTROL

- Friendly hexes are hexes solely occupied by friendly units.
- Enemy hexes are hexes solely occupied by enemy units.
- Empty hexes are unoccupied.
- Battle hexes are hexes occupied by units of both sides.

Battle hexes are controlled by the side that occupied the hex when the battle began (the *defender*).

## 1.3 STACKING

Stacking refers to the number of units that are allowed to occupy one hex. In *Rommel in the Desert*, **any number** of units may occupy a hex.

## 1.4 TERRAIN

Terrain applies to **Hexsides**, not hexes. The terrain of a hex itself has no effect on play, and is shown only to help define Hexside terrain.

*Rough* terrain Hexsides are **impassable**, unless a *Gap* is shown and/or a road passes through the Hexside. In these cases entry into battles is constricted (see 7.1). Rough terrain on the map includes:

- *Mountains* (Jebel el Akhdar),
- *Ridges*, and
- [salt] *Marshes*.

All other Hexsides are *Clear* terrain. Only the land portion of coastal hexes is playable.

## 1.5 ROADS

Three 'grades' of *Road* are shown on the map: *highway*, *tracks*, and *trails*.

Units can move faster along Roads (regardless of terrain), *Highway* is fastest, then *tracks*, and finally *trails*.

Supply Lines (12.2) are also more easily formed along Roads.

## 1.6 BASES

Each player has one *Base*. The Axis Base is El Agheila near the **western** map edge. Alexandria, the Allied Base is located at the **eastern** map edge.

New units (*Reinforcements*) arrive in Base, and damaged units can be rebuilt there. Bases are the main Supply Source for each side and are ports for Sea Redeployment.

Players must be careful to protect their Bases, as losing them to the enemy results in immediate defeat.

## 1.7 FORTRESSES

Benghazi, Tobruk, and Bardia are *Fortresses*. Fortresses provide a considerable combat advantage to defending units, and can serve as a Supply Source for a limited number of units isolated from their Base.

Fortresses also act as ports: the number shown is its *Port Capacity*, which governs its Sea Redeployment and independent Supply capabilities.

Capturing an enemy Fortress gains a player additional 'bonus' Supply Cards in the next Buildup.

See 13.0 for details.

## 1.8 OASES

Jalo, Siwa, and Jarabub are *Oases*. An Oasis can automatically Supply one unit in that hex (no external Supply Line is necessary).

Note the hex distortion near Siwa and Jalo so that these oases can be represented on the map. The distorted hexes are played as normal hexes.

## Hexside Control

Control of *Hexsides* in battle hexes can also be important to play (e.g., re-establishing supply lines into battles and allowable movement routes out of them).

See 8.1 for details.

## TERRAIN TYPES



### MOUNTAIN

Passable only along roads.  
Hexside Limit: 1



### RIDGE

Impassable



### GAP/PASS

Hexside Limit: 1



### MARSH

Impassable



### CLEAR

Hexside Limit: 2



BASE



FORTRESS



OASIS



TOWN



HIGHWAY



TRACK

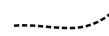

TRAIL

# ROMMEL IN THE DESERT™

## 2.0 UNITS

The colored wooden blocks are the playing pieces, or *units* in the game. A die-cut adhesive label showing unit type and strength must be attached to the face of each block. Cover minor imperfections with labels and use any defective blocks for battle markers. A few extra blocks are included in case of severe defects.

## 2.1 NATIONALITY

German units are **black** blocks with dark green labels. Italian units are **black** blocks with light green labels.

Allied units are **red** blocks with tan labels. Central colors denotes Commonwealth forces.

## 2.2 UNIT TYPE

A unit's *type* is shown by the central symbol on its label.

Units are categorized into one of four [arms] *classes* (armor/ infantry/ antitank/ artillery) and *speeds* (1-4 hexes). Each *unit type* is a combination of class and speed. See: Unit Types Chart.

All units of a given unit-type have identical speed and combat firepower, so these are not shown on the label.

## 2.3 COMBAT VALUE (CV)

The large numbers surrounding the unit symbol show the unit's strength, called *Combat Value* ("CV").

Units gain and lose strength in steps of 1 CV (2 CV for *elite* units). A unit's current CV is the number along the top edge when standing upright.

Units generally begin a scenario at maximum CV, and are reduced by combat but can be rebuilt. Losses and rebuilds are handled by rotating the unit until the new CV level is on the top edge. A unit reduced below its lowest CV is eliminated from the game and cannot be rebuilt.

## 2.4 ELITE UNITS

All **German** units (not Italians) and some Allied tank units (center symbol filled-in) are *elite*, having two CV per step instead of one.

**Two** hits are necessary to reduce an elite unit by a step (see 9.5).

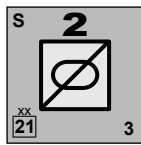

**Recon**  
Weak, high-speed units composed of light tanks and armored cars (some mounted with light cannon.)

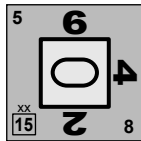

**Armor**  
Tank units with strong offensive punch.

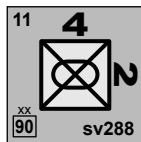

**Mechanized Infantry**  
Infantry mounted in armored personnel carriers (APCs), which could carry them into the battlefield at speed.

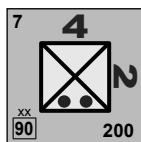

**Motorized Infantry**  
Infantry riding in trucks, able to move quickly, but forced to dismount and walk as they approached the enemy.

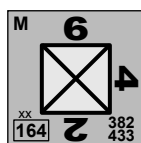

**Unmotorized Infantry/Paratroopers**  
Leg infantry, with gravely impaired usefulness in a war of movement.

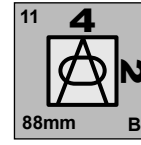

**Mobile Anti-Tank**  
Anti-tank guns with intrinsic towing units of good cross country mobility.

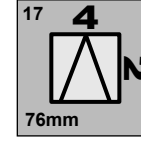

**Motorized Anti Tank**  
Anti-tank guns dependent on truck pools for transport.

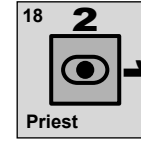

**Self Propelled Artillery**  
Artillery mounted in tank chassis with excellent cross-country mobility.

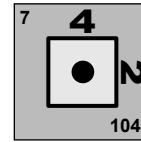

**Artillery**  
Field artillery also dependent on truck "pools", but effectively slowed by greater size and weight.

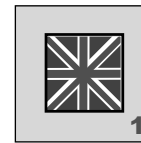

**Battle Marker**  
Place the Battle Marker of the Defender's color in the battle hex and the corresponding Battle Marker of the Attacker's color with the Battle array.

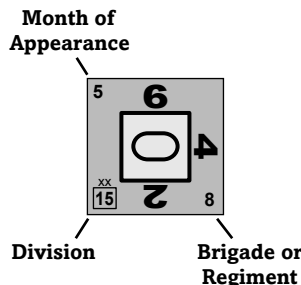

### UNIT SYMBOLS

AU	Australian
IN	Indian
NZ	New Zealand
SA	South African
FF	Free French
Pol	Polish
H	Highland
Tob	Tobruk
AT	Army Tank
G	Guards
m	Motor
SG	Support Group

### Center Color

Red
Green
Light Blue
Orange
Dark Blue
Red borders

### MONTH OF APPEARANCE

S	Starts 1941 scenario or campaign.
T	Starts 1941 scenario or campaign in Tobruk.
M	Malta Group (see 1942 scenario).

UNIT TYPES CHART					
	SPEED	ARMOR CLASS	INFANTRY CLASS	ANTITANK CLASS	ARTILLERY CLASS
RECON	4				
MECHANIZED	3				
MOTORIZED	2				
UNMOTORIZED	1				

# ROMMEL IN THE DESERT™

## 3.0 SEQUENCE OF PLAY

Begin by dealing Supply Cards and deploying Starting Forces as specified for the Scenario (18.0).

### 3.1 GAME MONTHS

Each *Month* of play consists of Buildup, Initiative, and a variable number of alternating Player-Turns. A Month of play ends when both players Pass (4.5) in succession.

### 3.2 BUILDUP

Each Month begins with a *Buildup* phase for each player (however, no Buildup occurs before the first Month of a scenario). See section 16.0.

### 3.3 INITIATIVE

The Axis normally has the first Player Turn of a Month (the *Initiative*).

**Initiative Challenge:** The Allied player may challenge for the Initiative by playing a (real or dummy) Supply Card **face down**. The Axis player may then play a card of his own (or not).

If the Allied card is **real** and the Axis has **not** matched it with a real one, the Allies seize the Initiative. Otherwise, the Axis retain the Initiative.

Supply cards committed to an initiative challenge are expended regardless of the outcome.

**Important:** *In the first Month of all scenarios no challenge is allowed. Also note the Crusader Scenario begins with an Allied Player-Turn.*

### 3.4 PLAYER TURNS

Each *Player Turn* is a sequence of phases which must be performed in order. The *Active* Player is the player taking his turn; his opponent is the *Passive* Player.

#### 3.4.1 INITIAL SUPPLY CHECK

The Active Player checks Supply status of all **friendly** units and recovers Disrupted units according to 12.7.

#### 3.4.2 SELECT TURN OPTION

A *Turn Option* (4.0) is a combination of Movement and Combat phases costing a defined number of real Supply cards.

Each Player Turn, the Active Player secretly selects one Turn Option by playing the required number of **real** Supply cards **face-down** (extra dummy cards may be played to deceive the enemy).

#### 3.4.3 MOVEMENT

During a Movement phase, the Active Player can make Group (5.1) and/or Regroup (5.2) moves according to the Turn Option selected. Forced Marches (6.4) are resolved after all other movement.

**Refusing Battle:** When an *Attack* (new battle) occurs, the Passive Player may choose to *Refuse Battle* (10.2).

All Movement (including Forced Marches and Refusing Battle) must be done before the Combat phase begins.

#### 3.4.4 COMBAT

During a Combat phase, the Active Player may initiate one *Combat Round* in any or all current battles.

See Battles (8.0) and Combat (9.0).

#### 3.4.5 BLITZ MOVEMENT

In Blitz Turns, the Active Player has a **second** pair of Movement and Combat phases following the normal Movement and Combat phases (but a unit **cannot** move twice in a Turn).

All Blitz Movement must be done before the Blitz Combat phase begins.

#### 3.4.6 BLITZ COMBAT

In Blitz Turns, the Active Player gets another Combat phase following Blitz Movement. A unit **can** fire in both COMBAT phases.

#### 3.4.7 FINAL SUPPLY CHECK

The Supply status and Disruption of the Active Player's units is checked according to 12.7.

#### 3.4.8 SUPPLY REVEALED

The Active Player reveals the Supply Cards played. All Cards played are now discarded.

## BUILDUP SEQUENCE

ADVANCE MONTH  
BUILDUP SUPPLY CHECK  
BP DETERMINATION  
FIRST PLAYER BUILDUP  
Reinforcements  
BP Expenditure  
Replacements & Redeployments  
Minefield Construction  
Allocate BPs for Extra Supply  
Resupply (draw all cards at once)  
Monthly Resupply  
Extra Supply (allocated above)  
Bonus Supply (*Fortress Capture*)  
SECOND PLAYER BUILDUP  
(repeat player 1 procedure)

## PLAYER-TURN SEQUENCE

INITIAL SUPPLY CHECK  
Determine Unit Supply  
Disruption Recovery  
TURN OPTION SELECTION  
Supply Commitment (hidden)  
MOVEMENT  
Group/Regroup Move(s) [R\*]  
Retreats (Full and Partial)  
Probe Combat (if Partial)  
Pursuit Fire (Retreating units)  
Move/Disrupt Retreating Units [R\*]  
Forced Marches  
Refuse Battle (Passive Player)  
Pursuit Fire  
Withdrawal [R\*]  
COMBAT (not Pass Turn)  
Active Battles  
Defensive Fire [R\*]  
Offensive Fire [R\*]  
BLITZ MOVEMENT (Blitz Turn)  
(as MOVEMENT)  
BLITZ COMBAT (Blitz Turn)  
(as COMBAT)  
FINAL SUPPLY CHECK  
Disrupt Unsupplied units [R\*]  
SUPPLY CARDS REVEALED

[R\*] ROUT POSSIBLE (Interrupts Play)  
Rout Attrition  
Pursuit Fire  
Withdrawal Move  
Continue Play

### Blitz Movement and Combat

These phases occur **only** during Blitz Turns.

A unit cannot move in both Movement phases of a Blitz Turn, but **can** fire in both Combat phases.

# ROMMEL IN THE DESERT™

## 4.0 TURN OPTIONS

Each Player Turn, the Active Player secretly selects (and commits Supply for) one of the following Turn Options (dummy Supply Cards may be played to confuse the opponent).

In the Turn Option descriptions given below, a *Move* means one Group or Regroup Move during the Movement phase; a *Combat Round* means the option to initiate combat in any or all battles during the Combat phase.

### 4.1 THE BASIC TURN

The BASIC TURN costs one (1) real Supply Card and allows the player one Move and one Combat Round.

### 4.2 THE OFFENSIVE TURN

An OFFENSIVE TURN costs two (2) real Supply Cards, and allows the Active Player to make two Moves (during the same Movement phase), and one Combat Round. Remember: a unit can only move **once** per turn.

### 4.3 THE ASSAULT TURN

An ASSAULT TURN also costs two (2) Supply Cards. It allows the Active Player to make one Move, plus an **Assault Combat Round**.

In an Assault Combat Round, the Active Player has the option to designate any or all current battles as *Assaults*, in which units of both sides fire Double Dice (see 9.21). Other battles may be fought normally or not at all, as desired by the Active Player.

### 4.4 THE BLITZ TURN

A BLITZ TURN costs three (3) real Supply Cards. BLITZ TURNS allow the Active Player **two** BASIC TURNS in succession (except that units cannot move twice).

The Active Player has one Move and Combat Round during the regular Movement and Combat phases, then makes a second Move (with different units) and Combat Round during Blitz Movement and Blitz Combat. Units **are** allowed to fire in both Combat phases of a BLITZ TURN

Hexside limits (7.1) are reset for the Blitz Movement phase, so that additional units may enter a battle hex via hexes **already** traversed in the initial Movement phase.

## 4.5 THE PASS TURN

A PASS TURN costs **no** Supply Cards, allowing players to conserve Supply while awaiting events.

In a PASS TURN, the Active Player is allowed to make **one** Withdrawal Move (5.3) if he desires, but no other movement or combat can occur.

If both players *Pass* in succession the current Month of play ends.

### Dummy Supply Card

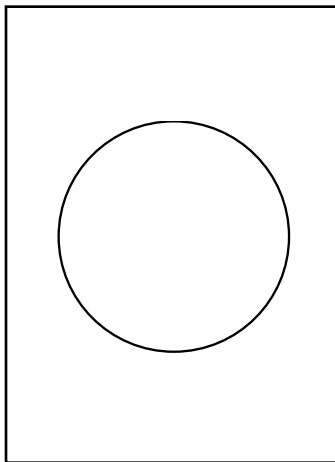

### Real Supply Card

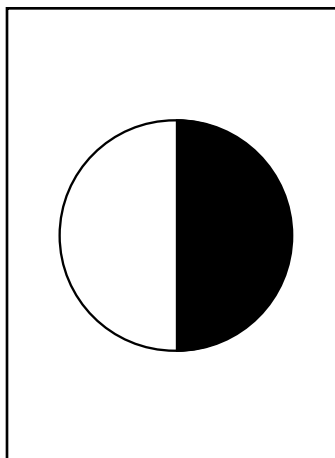

## TURN OPTIONS

●	BASIC	MC
●●	OFFENSIVE	MMC
●●	ASSAULT	MC*
●●●	BLITZ	MC + MC
No Cost	PASS	(W)

**M** = Move Phase **C** = Combat Phase  
**\*** Any/All battles can be Assaults.  
**(W)** = 1 optional withdrawal move

### Turn Option Deception

The Active Player could play 1 real Supply Card for a Basic Turn and add a dummy Supply Card to bluff his opponent into thinking that an Assault Turn is underway. This might convince the Passive Player to Refuse Battle rather than accept battle and risk possible double dice combat.

### Two Supply Cards Committed: Assault or Offensive Turn?

When 2 real Supply are committed to a Turn Option, it might seem at first glance that the Active Player may be able change his Turn Option in mid-turn.

However, the Active Player taking an Offensive Turn must make two Group or Regroup Moves in the Movement phase. Doing so reveals that he is taking an Offensive Turn before any opponent decisions (e.g., Refuse Battle) are made.

If a player commits 2 real Supply Cards and does not take 2 Moves in the Movement phase, he is committed to an Assault Turn.

### Assault Turns

In an Assault combat, both sides fire Double Dice, which might seem of no advantage to the Active Player. However, the ability to win a battle rapidly (even at the cost of higher casualties) can prove crucial at times.

### The Pass Turn

Passing in a Player Turn in no way limits the future options of that player. A Player that Passes on one Player-Turn may play a different Turn Option on the next turn.

The opponent may continue to play other Turn Options while a player continues to Pass (provided he has supply available)

# ROMMEL IN THE DESERT™

## 5.0 GROUP MOVEMENT

A *Group* consists of all friendly units occupying a hex. There is no limit to Group size: **any number** of units may occupy a single hex.

**All** movement during Player Turns is made in terms of Group Movement. A *Move* involves the movement of one specific Group (either dispersing an existing group or concentrating forces into a new one). Depending on the Turn Option (4.0) selected, players make 1 or 2 Moves per Player Turn.

There are two types of Move: *Group Moves* and *Regroup Moves*.

When moving Groups, rules for individual unit movement (6.0) must also be observed. There is a limit to the number of units that can enter a **battle hex** via a single Hexside (7.1), but no Hexside Limit otherwise.

## 5.1 THE GROUP MOVE

In a *Group Move*, any or all units from one hex may be moved to one or more destination hexes. Units that begin their movement together are not required to remain as a Group, and may disperse to separate locations.

To make a Group Move, the Active Player indicates the desired group and then moves units individually to one or more hexes of his choice, observing the movement speed of each unit.

## 5.2 THE REGROUP MOVE

In a *Regroup Move*, any or all units in or adjacent to a designated *Command Point* hex (regardless of intervening terrain) may move to a common *destination* hex, uniting into a new Group.

The *Command Point* may be a friendly, empty, or battle hex, but not an enemy hex. The destination hex can be **Friendly, Enemy, Empty or Battle** (thus, Regroup Moves can be used to Attack as well as Retreat).

To make a Regroup Move, the Active Player indicates the Command Point and the destination hex, then moves regrouping units individually.

Again, the movement speeds of individual units must be observed. Units unable to reach the destination hex of a Regroup may not move **at all**.

## Regroup Moves

The distance a unit can move is measured from its original location, not from the Command Point.

## Regrouping Forced Marches

Units may attempt a Forced March (6.4) to the destination hex of a Regroup Move, but if unsuccessful they are Disrupted **at their original location**.

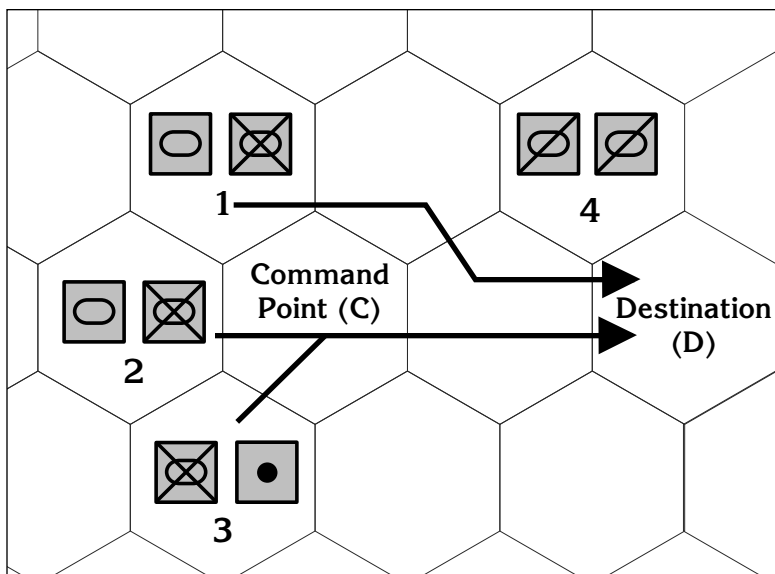

## REGROUP EXAMPLE

The five Allied units in hexes [1], [2], and [3] Regroup to hex [D], using hex [C] as the Command Point. The artillery unit on hex [3] cannot Regroup because it does not have the speed to reach [D]. Units in hex [4] are not adjacent to the Command Point [C] and therefore cannot be part of the Regrouping move.



# ROMMEL IN THE DESERT™

## 5.3 WITHDRAWAL MOVES

A *Withdrawal Move* is a strictly defined kind of Group/Regroup Move that is made **without Supply Card expenditure**. Withdrawals are Moves where each unit moves back along one of its own Supply Lines territory is conceded.

Withdrawal Moves are the **only** type of Move possible without spending a Supply Card. They can occur in three different ways:

- The **One** Withdrawal Move allowed in a PASS TURN.
- Withdrawal Moves made by the Passive Player to Retreat groups that Refuse Battle.
- Withdrawal Moves made to Retreat groups that are Routed (11.3).

A Group or Regroup Move must satisfy **all** of the following conditions to qualify as a Withdrawal Move:

- 1) Each moving unit must have a valid Supply Line (12.2) as the Withdrawal Move begins.
- 2) Each unit can only move along one of **its own** Supply Lines and each hex entered must shorten that Supply Line.
- 3) The friendly Supply Network (12.6) must be reduced by at least one hex.
- 4) No unit movement is made physically away from the Supply Source (in hexes).

**Exception:** See sidebar regarding *Bardia-Ft. Capuzzo*.

Withdrawing units cannot Engage enemy forces (unless the latter are Disrupted - see sidebar).

### Withdrawals into/through hexes containing Disrupted Enemy Units

Withdrawing units that are not Retreating can Engage & Rout Disrupted enemy units.

Withdrawing units that **are** Retreating (hence becoming Disrupted themselves) can pass through (or co-exist in the same hex with) enemy Disrupted units, with no effect on either force. If Disrupted units of both sides occupy the same hex, the first group to recover will Rout the other.

### Withdrawals into Fortress Supply

Units assigned Fortress Supply (13.3) may withdraw along a Supply Line leading to the Fortress. Units theoretically capable of tracing Supply to a Fortress but not assigned Fortress Supply cannot do so.

### Supply Lines for Withdrawal

Supply Lines for Withdrawal Moves are defined at the moment of the Withdrawal.

### Bardia-Ft Capuzzo Withdrawals

The Coast Highway 'jogs' backwards slightly at Bardia/ Ft. Capuzzo. To allow for this, the Axis player may consider these two hexes to be equally distant from the friendly Base. Withdrawals following the highway **in the direction of the Axis Base** are allowable in this special case [only], even when the hex entered is further from Base in absolute hexes.

## Withdrawal Example

An Axis recon unit is in Mechili with two other Axis units in Msus and Charruba forming Supply Chains to the highway (Benghazi friendly). No Allied units are west of Tobruk.

The Mechili unit has 8 valid supply lines to the highway:

- |                               |                           |
|-------------------------------|---------------------------|
| 1) Mechili-Msus-Agedabia      | 5) Mechili-Msus-Er Regima |
| 2) Mechili-Msus-Beda Fomm     | 6) Mechili-Derna          |
| 3) Mechili-Msus-Ghemines      | 7) Mechili-Gazala         |
| 4) Mechili-Charruba-Er Rejima | 8) Mechili-Bir Harmat.    |

The recon unit can Withdraw along any of the first 4 routes (none move physically away from Base). The other 4 Supply Lines are not valid for Withdrawal Moves as they involve movement physically away from Base.

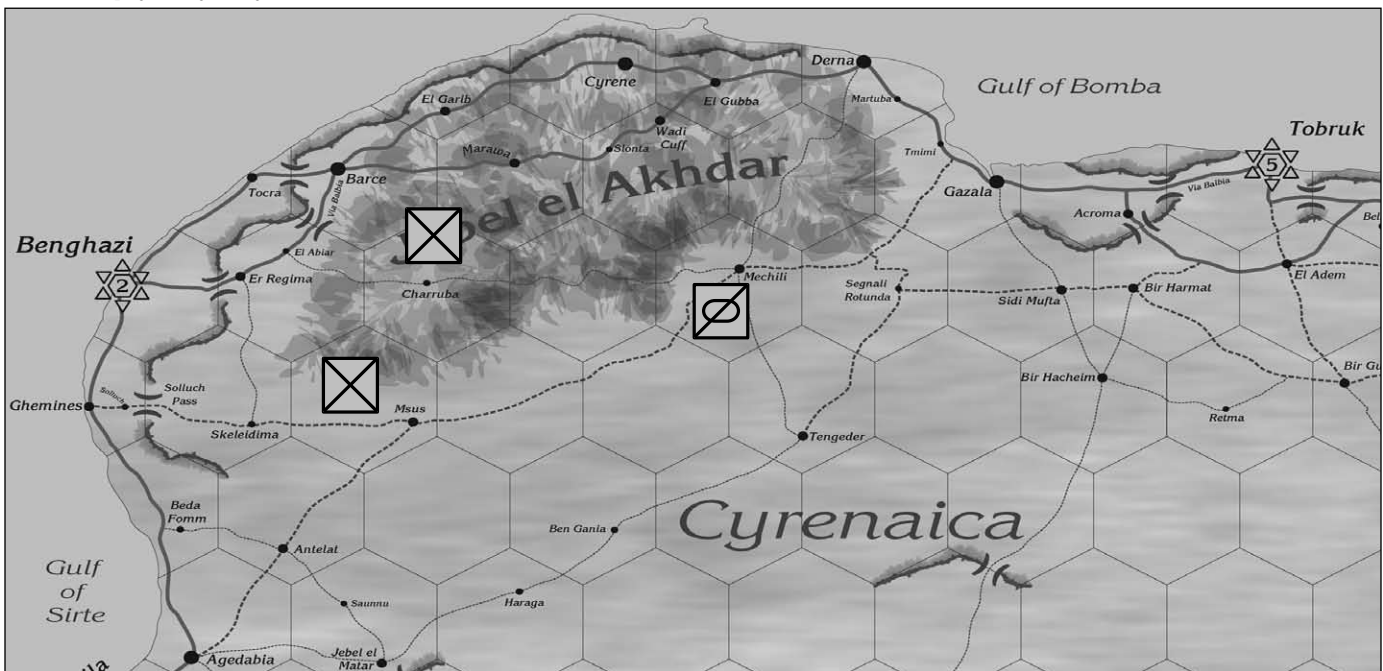

# ROMMEL IN THE DESERT™

## 6.0 UNIT MOVEMENT

The number of hexes an individual unit can move is its movement speed.

Units can move freely through friendly or empty hexes, but must STOP upon Engaging (i.e., entering a hex containing enemy units).

Units can **never** move more than once per Player-Turn (except to Rout).

### 6.1 UNIT SPEED

The basic movement speed of all units is shown on the UNIT SPEED TABLE (sidebar). A unit may move 1-4 hexes (depending on its speed) plus any applicable movement bonuses.

### 6.2 ROAD BONUSES

Roads include highways, tracks and trails. Units moving **entirely** along Roads receive movement bonuses:

- Highway +4 hexes
- Tracks +2 hexes
- Trails +1 hex

To receive a Road Bonus, a unit must start, remain on, and end its move on some type of Road. When two types of Road are used, the lesser bonus applies.

### 6.3 ROMMEL BONUS

During every Axis Player-Turn (except in 1940), the Axis player can designate any one Group or Regroup Move as *Rommel's Move*. All Axis units involved in that move receive a movement bonus of +1 hex (in addition to any applicable road bonus).

### 6.4 FORCED MARCHES

The Active Player may attempt to *Force March* units one hex past their normal maximum range, at the risk of Disruption (11.0).

After all Moves are complete, the Active Player announces all Forced March attempts (units and desired destinations), and rolls one die each.

On a roll of 4, 5 or 6, the attempt succeeds, and the unit moves the extra hex. On a roll of 1, 2, or 3, the attempt fails and the unit is Disrupted (in its current hex if this was a Group Move or in its original hex if a Regroup).

## 7.0 ENGAGEMENT

Entering a hex containing enemy units is Engaging.

Entering a hex containing **only** enemy units is Attacking (as well as Engaging). See 8.2.

### 7.1 HEXSIDE LIMITS

There is a limit to the number of units able to Engage enemy forces **across the same Hexside** in a single Movement phase.

For *Clear* terrain Hexsides, the limit is **two** units per Movement phase (i.e., six units could enter a battle hex via three *clear* Hexsides).

For *Gap* Hexsides and roads through *mountains*, the limit is **one** unit per Movement phase.

**Remember:** *Units can only cross Mountain hexsides where a Road exists and Ridges/Marshes through a Gap.*

During Blitz Movement, Hexside limits are reset: additional units can Engage via Hexsides already traversed.

### 7.2 DISENGAGEMENT

Units that leave a hex containing enemy units are *Disengaging* (except during Buildup, see 16.51). Units can only Disengage through Friendly Hexsides (8.1). Units that Disengage are **always** Disrupted (11.0). Hexside limits **do not** apply when Disengaging.











Disengaging units are turned upright before moving out of a battle hex and turned face-down (Disrupted) after they finish movement. They **cannot** re-engage this Player Turn.

When **all** friendly units Disengage from a hex, it is a *Full Retreat* (10.3). If **some but not all** friendly units Disengage from a battle hex, it is termed a *Partial Retreat* (10.4).

### 7.3 REVEALING UNITS

Units engaging into a Battle are not revealed until all Movement is complete. Once revealed, units remain face-up until they Disengage or until the battle ends.

## UNIT SPEED

 RECON	4
 ARMOR	3
 MECH. INF.	
 MOB. A/T	2
 SELF PROP. ARTY.	
 MOT. INF.	1
 MOT. A/T	
 INFANTRY	1
 PARA	
 ARTILLERY	

### Road Bonus Example

A Recon unit (speed 4) can move up to 8 hexes along the highway, 6 hexes along tracks, and 5 hexes on trails.

The unit could move up to 5 hexes along a combination of tracks and trails.

Road bonuses do apply in all types of movement (including Retreats and Redeployments).

### The Rommel Bonus

The Rommel Bonus can **only** be used by an active Axis player during Movement or Blitz Movement (not both).

It cannot be used by a passive Axis player for Withdrawal Moves to Refuse Battle or Rout, or to Redeploy in Buildup.

### Regrouping Forced Marches

Units may attempt a Forced March to the destination hex of a Regroup Move, but if unsuccessful they are Disrupted at their original location (units that cannot Regroup to the destination hex cannot move at all).

### Forced Marches into Battle

Players cannot attempt to Force March into engagements in excess of Hexside Limits (anticipating that some units will fail to arrive).

### Retreat Forced Marches

Units failing a Forced March when making a Retreat lose one step in addition to the usual Disruption that always happens to Disengaging units.

### Retreat vs. Disengagement

**Units** Disengage; **Groups** Retreat.

# ROMMEL IN THE DESERT™

## 8.0 BATTLES

A *Battle* is a hex containing units of both sides, where combat can occur.

Battles are not necessarily resolved immediately: they last until one side Retreats [10.0] or is eliminated. Battles can last through several Player Turns, sometimes even lasting for Months.

## 8.1 BATTLE HEXSIDES

Each Hexside of a battle hex is termed a *Battle Hexside*. Control of Battle Hexsides determines Supply Lines into battles and Disengagement routes out of them.

A Battle Hexside is *friendly* to the side whose units last engaged across it (and this takes effect instantly).

A Hexside that neither side has crossed is friendly to the *Defender* (8.3).

## 8.2 ATTACKS

Moving units into an *enemy hex* (one containing **solely** enemy units) is termed *Attacking*. Adding units to an existing battle hex is **not** an Attack.

The Passive Player can respond to an Attack either by accepting battle or by Refusing Battle (8.4). If battle is accepted, combat is mandatory that turn (8.5).

Disrupted units that are Attacked without friendly Undisrupted Shielding units present are Routed (11.3).

## 8.3 ATTACKER & DEFENDER

The player who initiates a battle is termed the *Attacker* in that Battle for as long as it lasts. The other player is the *Defender*. This distinction is very important because the Defender maintains control of *battle hexes* for Supply purposes.

## 8.4 REFUSING BATTLE

Immediately upon the completion of all enemy Moves (including Forced Marches), the Passive Player has the option to Refuse Combat and Retreat Attacked Groups by Withdrawal Move if possible (see 10.2).

The option to Refuse Combat is **not** open to Groups already engaged in Battles when Movement began.

## 8.5 BATTLE ARRAY

If battle is accepted, mark the hex with a Battle Marker of the **Defender's** color and move the units involved to a convenient location. Small battles may be fought in the hex.

Players then arrange their units in opposing Battle Lines (placing the corresponding Battle Marker of the **Attacker's** color nearby).

Players now reveal their units by turning them face-up, tipping **forward** toward the enemy line, so that its current CV is **toward** the enemy line.

## 8.6 ACTIVE BATTLES

In a Combat phase, the Active Player has the option to wage Combat in any or all current battles. Battles selected for Combat are termed *Active Battles*.

**Mandatory Combat:** In two cases, combat is mandatory: battles **must** be fought in that Combat phase:

- **New Battles:** combat is **required** in the first Combat phase of a new battle.
- **Fortress Battles:** the Attacker (but not the Defender) must wage combat every Combat round when engaged in a Fortress hex (except during Blitz Combat).

**Select Active Battles:** Before Combat begins, the Active Player must indicate all the Battles in which Combat is to occur by moving those Battle Lines closer together, and leaving other Battle Lines more separated.

**Select Assault Battles:** During ASSAULT TURNS, selected battles may be fought using *Assault Combat* (Assault Battles). In Assault Battles, **all** units (both Attacker **and** Defender) fire Double Dice (9.21).

Before Combat begins, the Active Player must pre-indicate Assault Battles by placing one or more friendly units **on top of** the defending line.

## Refusing Battle: Disrupted Units in the Group

When a group containing Disrupted units Refuses Battle, the Disrupted units are, of course, unable to Withdraw, being unable to move except to Rout.

First, the Undisrupted units suffer Pursuit Fire and then execute a Withdrawal Group Move. The Disrupted units are now Unshielded and are therefore Routed, suffering Rout Attrition **and** Pursuit Fire by (unfired Pursuing units, if any). If they survive, they can then Withdraw as a **separate** group.

## Refusing Battle: Units in the Group without a Supply Line

Since units without a Supply Line cannot Withdraw, and Partial Retreat is not allowed when Refusing Battle, a mixed group of units of which only some have a Supply Line may not Refuse Battle.

This situation can arise when a group is composed of units assigned Fortress Supply and other units with no Supply Line to Base.

## Battle Arrays

The position of units in the line is immaterial (though it helps to group units by arms class).

Artillery units can be placed behind the battle line to remind players that they can only be targeted by enemy artillery (unless unsupported).

## Fortress Combat in Pass Turns

The Original Attacker must have combat when engaged in a Fortress. Yet no Combat is allowed during a PASS TURN.

Therefore, if the Active Player Passes while engaged in a Fortress hex, he must Retreat his forces from the Fortress hex by Withdrawal Move. If this is not possible, the active player's forces are Routed (see 13.2).

# ROMMEL IN THE DESERT™

## 9.0 COMBAT

Once *Active Battles* are designated, they are resolved one by one, in any order chosen by the Active Player.

Each Combat phase involves one *Combat Round* in each **Active Battle**, in which each unit fires once. All firing in one Battle must be completed before proceeding to the next battle.

## 9.1 COMBAT ROUNDS

A Combat Round is executed in each Active Battle as follows:

- 1) The Passive Player fires Defensive Fire and losses are applied.
- 2) The Active Player fires Offensive Fire and losses are applied.

## 9.2 UNIT FIRE

In Defensive or Offensive Fire, each unit fires once in any desired order, except that artillery must fire **first**.

To fire a unit, the firing player indicates the unit firing and the **class** (armor/infantry/anti-tank/artillery) being targeted, and rolls one die per firing unit CV (3 dice for 3 CV units).

Depending on the unit's Firepower (9.4) versus the selected target class, certain numbers rolled score hits, reducing the CV of enemy units in the target class.

### 9.21 DOUBLE DICE

In Assault Combat and Fortress defense, units fire *Double Dice*, meaning they roll twice the normal number of dice (at normal Firepower).

## 9.3 TARGETING

Some unit classes must fire at their enemy counterparts if present: Armor-class units must fire at armor-class units, if present. Similarly, infantry-class units must fire at infantry-class units, if present. Artillery and antitank class units are not restricted in this way. Only artillery can target enemy artillery, unless no other class of target unit is present. Target class **must** be announced before firing a unit.

If all units of a **required** target class are eliminated, unfired units may fire at other target classes.

## 9.4 FIREPOWER

The effectiveness of fire depends on the class of unit firing and its target. Cross-referencing the firing unit-class and the target class on the FIRE TABLE (see Map) shows fire effectiveness.

- "SF" stands for "single fire" and scores one hit for every "6" rolled.
- "DF" (double fire) scores a hit for every "5" or "6" rolled.
- "TF" (triple fire) scores a hit for every "4", "5", or "6" rolled.

## 9.5 APPLYING LOSSES

For each *hit* scored by enemy fire, a unit of the targeted class is reduced by 1 CV (owner's choice of exact unit).

**Elite Units:** All German units and some Allied armor units are *elite*, with 2CV per step. **Two hits** are necessary to reduce them by a step. All hits on a given arms **class** must be applied if possible and leftover hits at the end of a combat round are wasted.

Within an arms class, the owning player may allocate hits to individual units **as desired** (except *hits* may only be wasted if there is no alternative).

As *hits* are received, the owning player **provisionally** allocates them to units of the target class, only finalizing this when all enemy fire is complete. Single hits allocated to elite units are indicated by rotating the unit 45°.

If sufficient hits are inflicted within a combat round to eliminate all units of a target class, they are removed from play which may affect subsequent targeting of opponent fire.

### 9.52 DOUBLE DEFENSE

Double Defense applies to the Defenders in a Minefield. Hits scored on Minefield Defenders are considered *half-hits*, and it requires two *half-hits* to inflict a 1 CV loss.

**Exception:** *Artillery fire is unaffected by Minefields and scores full hits.*

As for *elite* units, *half-hits* are provisionally allocated to units within the target class. At the end of a Combat Round, leftover *half-hits* on a given target class are wasted.

## Unit Fire

A unit must fire all its CV simultaneously at a single target class, and cannot switch targets in a Combat Round, even if all units of the target class are eliminated.

### Unit Fire Example

A 6 CV armor unit fires on enemy infantry (no enemy armor present) at fire effectiveness of double fire (DF).

A die roll of 4, 5, 1, 6, 3, 3 scores two hits.

### Double Dice Unit Fire Example

A 3 CV Infantry unit defending a Fortress rolls 6 dice (3x2) for defensive fire.

Firepower remains the same (e.g., SF when targeting enemy infantry).

### Targeting Artillery

Artillery can only be targeted by enemy artillery, unless no other class of friendly unit is present in the battle (Disrupted units are ignored for targeting purposes).

Artillery unsupported by any other arms class is extremely vulnerable. All units except artillery fire on unsupported enemy artillery at Triple Fire.

### Firepower Example

If enemy armor is present in a Battle, an armor unit must target it at SF.

However, when no enemy armor is present, the same armor unit can fire on enemy infantry at DF.

### Applying "Half Losses"

When all units of a given target class are elite, leftover "odd" hits at the end of a Combat Round will be wasted.

For example, if all Axis armor in a battle is elite, and the Allies score 3 hits on enemy armor in a combat round. Two hits are applied to reduce a German armor unit by one step and the leftover hit is wasted.

The same principle applies to units with Double Defense in a Minefield.

### Applying Losses to Mixed Groups

When a target class is a mix of elite and normal units, all hits must be applied.

**Example:** Three armor hits are scored in a combat round where there are both elite and normal armor targets. Either 2 hits are applied to elite armor and 1 hit to normal, or all 3 hits are applied to normal armor.

Players should apply hits provisionally.

For instance, a 1 CV unit hit by enemy fire should not be removed from play until the end of the combat round since an ensuing 2nd hit may have to be applied to an elite double-step unit instead.

# ROMMEL IN THE DESERT™

## 10.0 RETREATS

Disengaging (7.2) all units from a battle hex is a Full Retreat (10.3). If some, but not all, units Disengage it is a Partial Retreat (10.4). Units that Disengage are **always** Disrupted (11.0).

Voluntary Retreats can occur when Refusing Battle (10.2) by Group Withdrawal Move, or by a Group or Regroup Move during a Player Turn (including by Withdrawal Move during a PASS TURN). Involuntarily Retreats occur (by Withdrawal Move) when Disrupted units are Routed (11.3).

**Important:** *Disrupted (11.0) units cannot move (except to Rout) and are therefore exempt from all Retreat rules.*

## 10.1 RETREAT ROUTES

Units can **only** Disengage through **friendly** Battle Hexsides (8.1) into friendly or empty hexes, never directly into an *enemy* or *battle* hex. They may then continue to move as normal, but may **not** re-engage this Player Turn.

Units **forced** to Disengage but unable to do so are **eliminated**.

## 10.2 REFUSING BATTLE

Immediately following **all** enemy Movement, the Passive Player may *Refuse Battle* by Retreating **all** units of any Groups **just Attacked** (8.2) by Withdrawal Move (5.3). Regroup Moves or Partial Retreats to Refuse Battle are not allowed. As usual, the retreating units are subject to Pursuit Fire and become Disrupted. When Refusing Battle, units are not revealed.

## 10.3 FULL RETREATS

The Active Player may voluntarily Retreat **all units** from existing battles by Group or Regroup Move (including by Withdrawal Move 5.3). Retreating Groups are subject to Pursuit Fire (10.5) and become Disrupted (11.0).

## 10.4 PARTIAL RETREATS

*Partial Retreats* involve Disengaging **some but not all units** from a battle. Partial Retreats can **never** be made by Withdrawal Move: they require the use of a Supply Card. Partial Retreats **may** avoid Pursuit Fire.

After completing all other Movement, turn the Disengaging units **upright**. All **Undisrupted** units remaining in the Battle are the *Rearguard*. The Rearguard must survive a round of *Probe Combat* to protect the Disengaging units from Pursuit Fire.

**Important:** *When making a Partial Retreat you cannot initiate Combat in that battle during the same Player Turn.*

### 10.41 PROBE COMBAT

**Before** units making a Partial Retreat actually move, the Passive Player **may** provoke a round of *Probe Combat* (no Supply Card expenditure required).

In Probe Combat the Offensive/Defensive roles are **reversed**: first the **Active** Player's Rearguard unit(s) fire Defensive Fire, then the Passive Player returns Offensive Fire (see sidebar).

If **all** enemy Rearguard units are eliminated, **unfired** Probing units may immediately conduct Pursuit Fire (10.5) against the **upright Disengaging** units (treated as a Group). Surviving units then resume their Disengage move. If the Passive Player declines Probe Combat or the Rearguard is **not** eliminated by it, the Disengaging units are not exposed to Pursuit Fire (10.5).

## 10.5 PURSUIT FIRE

Groups that Retreat for any reason must take *Pursuit Fire*. Pursuit Firepower is based on unit **speed**.

The Retreating player announces the speed of his **slowest** Retreating unit. The pursuing player then rolls **one die** for each equally-fast **unit** in the [former] battle hex, and two dice for each faster **unit**. Slower units do not pursue.

One hit is scored for each die roll of 4, 5, or 6. The Retreating player must immediately apply losses to any Retreating units as desired as per 9.5.

### Refuse Battle Procedure

- 1) The Passive Player announces his intent to Refuse Battle, leaving units upright in the battle hex (not revealed).
- 2) The Active Player conducts Pursuit Fire against Retreating units, saving fire for Routs as desired. Pursuing units are not revealed either.
- 3) The Passive Player moves surviving units by Withdrawal Group Move.
- 4) Any Disrupted units remaining are Routed (11.3) and subject to Pursuit Fire by unfired units.

### Full Retreat Procedure

- 1) The Active Player moves all other units, announces the Retreat and turns Retreating units upright in the battle hex.
- 2) The Passive Player conducts Pursuit Fire against Retreating units.
- 3) The Active Player moves surviving Retreating units according to the Group or Regroup Moves underway.
- 4) Any Disrupted units remaining in the Retreat hex are Routed (11.3) and subject to Pursuit Fire by unfired units.

### Partial Retreat Procedure

- 1) The Active Player moves all other units, announces the Partial Retreat and turns Disengaging units upright in the battle hex.
- 2) The Passive Player may provoke Probe Combat. If the Rearguard is eliminated by Probe Combat, the Partial Retreat becomes a full Retreat. Continue with Retreat Procedure above, starting with 2).

### Reversed Roles in Probe Combat

If Rearguard units are Original Defenders, they receive full Fortress and/or Minefield defensive benefits, while the Probing units do not.

### Pursuit Deception

Pursuit Fire for some units may be withheld to disguise the nature of the group. Or, because each unit can only fire once, a player may reserve the fire from some pursuing units for enemy Disrupted units about to be Routed.

### Pursuit Fire in a Combat Phase

Pursuit Fire can occur during a Combat phase when Disrupted units in a battle hex are Routed after elimination of all friendly Shielding units. Only units that have not yet fired in combat may conduct Pursuit Fire.

# ROMMEL IN THE DESERT™

## 11.0 DISRUPTION

Units become Disrupted if they:

- Disengage from a battle (7.2),
- Refuse battle (10.2),
- Are Unsupplied (12.1) during **both** the Initial & Final Supply Checks, or
- Fail a Forced March (6.4).

To indicate Disrupted status, turn units **face-down** on the map (tip back toward the owner to preserve CV).

Units can remain Disrupted indefinitely, but are eliminated if Unsupplied (12.1) at the end of a month.

## 11.1 DISRUPTION EFFECTS

Disruption has temporary, but severe effects. Disrupted units cannot:

- Move (except to Rout)
- Impede enemy movement (they Rout immediately if Attacked)
- Fire or absorb hits in Combat
- Form part of friendly Supply Chains
- Block enemy Supply Lines
- **Redeploy or Return to Base during Buildup (see 16.5)**

### 11.11 DISRUPTED UNITS IN BATTLE

Disrupted units that are engaged are immediately Routed (11.3) unless *Shielded* by friendly **Undisrupted** units in the same hex.

Even if *Shielded*, Disrupted units take no part in battles (place them **face-down** behind the battle lines),

Disrupted units cannot recover while enemy units remain in the hex, but may do so once the battle is won (no enemy units remain in the hex). Disrupted units Rout immediately once no *Shielding* units remain.

## 11.2 DISRUPTION RECOVERY

Disrupted units *Recover* during the Initial Supply Check of a friendly Player-Turn, provided that they:

- Are not in a Battle hex,
- Have a Supply Line, and
- Have spent one **complete** enemy Player-Turn Disrupted (i.e., they do not recover if they Refused Battle or Routed in the previous enemy turn).

## 11.3 ROUT

Disrupted units in a battle hex without Undisrupted friendly *Shielding* units are *Routed*. This can occur if:

- Disrupted units are Attacked alone (i.e., not *Shielded*).
- Disrupted units become alone in a battle hex after all friendly *Shielding* units Disengage or are eliminated.

When a Rout occurs, its effects (below) are resolved immediately, interrupting the normal flow of play.

All Routed units must (in order):

- Lose one **step** of *Rout Attrition*
- Suffer Pursuit Fire (10.5)
- Retreat by Withdrawal Group Move, and they are **eliminated** if unable to do so)
- Become Disrupted again

## 11.4 OVERRUN

Disrupted units are immediately Routed when Attacked alone in a hex (i.e., no *Shielding* unit) and hence cannot seriously impede enemy movement.

Although a single Attacking unit can Rout a Disrupted enemy group, the Active Player can elect to Attack with multiple units so as to increase his Pursuit Fire (delaying Rout resolution to add more Attackers to the hex).

All Attacking units must **stop** in the Attacked hex (Hexside Attack limits apply), moving no further that turn.

However, after resolving the Rout, the Active Player may still have units qualified to move (as part of Group or Regrouping Moves already underway), but as yet unmoved. These units are then moved to complete the Move(s), including **through** the hex just Attacked (and now vacated of enemy units).

This entire process is termed *Overrun* of a hex containing Disrupted enemy units.

Multiple overruns can occur in the same Player Turn.

## Units Disrupted in Enemy Turns

Units that have become Disrupted are only able recover after spending an **entire** enemy Player Turn Disrupted.

This means units that become Disrupted **during** an enemy Player Turn (by Refuse Battle or Rout) remain Disrupted **through** the upcoming friendly Player-Turn **and** the next enemy Player-Turn, becoming able to recover only in the **second** friendly Player-Turn following Disruption.

## Routs

Rout Withdrawals must be made by the Passive Player when *Unshielded* (11.11) Disrupted units are engaged.

Routs also occur in the Active Player Turn if the Rearguard in a Partial Retreat is eliminated while *Shielding* friendly Disrupted units.

## Combat Phase Routs

When Disrupted units are Routed in a Combat phase (due to elimination of all friendly *Shielding* units in the same battle hex), only enemy units that have not yet fired in that combat round may conduct Pursuit Fire.

## Final Supply Check Routs

If units engaged in battle become Disrupted due to lack of a Supply Line, they are immediately **eliminated**, since units without a Supply Line cannot Withdraw.

## Overruns

In an OFFENSIVE TURN, units from both moving Groups may participate in the same Rout and/or Overrun (as they share the same MOVEMENT phase).

## Overrun Procedure

- 1) The Active Player moves one or more units into a hex containing **solely** enemy Disrupted units, and announces the Rout.
- 2) All Disrupted units in the Attacked hex lose **one step** of Rout Attrition.
- 3) The Active Player executes Pursuit Fire (10.5) against the Disrupted units.
- 4) The Passive Player must now Retreat surviving units by Withdrawal Group Move, if possible. If not, they are eliminated.
- 5) The Active Player now moves all unmoved units that are eligible to move as part of the Group/Regroup Moves already underway including through the Overrun hex just vacated by Routed enemy units.

# ROMMEL IN THE DESERT™

## 12.0 SUPPLY

Units in play are either *Supplied* or *Unsupplied*, depending on whether or not they had a Supply Line during the latest friendly Supply Check.

To be *Supplied*, a unit must be able to trace a Supply Line to a friendly *Supply Source*. This is normally the friendly Base, but a limited number of units may also trace Supply Lines to a Fortress (13.0). Oases also have very limited Supply capability (see 15.1).

## 12.1 UNSUPPLIED UNITS

Units that cannot trace a Supply Line during friendly Supply Checks are *Unsupplied*. Being *Unsupplied* causes no immediate harm (unlike *Disruption*). *Unsupplied* units can move, impede enemy moves, Engage or Attack, form or cut Supply Lines, capture Fortresses and Bases, etc.

However, units judged *Unsupplied* during the Initial Supply Check and still *Unsupplied* at the Final Supply Check become *Disrupted* (11.0).

## 12.2 SUPPLY LINES

A *Supply Line* is a continuous line of hexes leading **from** a unit **to** a friendly *Supply Source*.

**Supply Sources:** The main *Supply Source* for each side is its Base (El Agheila or Alexandria), which can Supply **any number** of friendly units. Fortresses can also act as *Supply Sources* for a **limited number** of units (13.3). Oases can Supply **one unit**, see 15.1.

Supply Lines are determined by the **position of units on the board** at the time of the Supply Check. They can be any length and are composed of sections of Highway and/or Supply Chains of friendly units. Units can have multiple Supply Lines.

Supply Lines can pass through friendly hexes, empty hexes, and battle hexes where the friendly side is the Defender (*Friendly Battles*). They cannot pass through enemy hexes, *enemy Battles* (enemy Defender), or through impassable Hexsides.

## 12.3 HIGHWAY SUPPLY

The coastal *highway* normally forms a Supply Line for both sides. Any stretch of highway that is not blocked by enemy units is a valid Supply Line. A Supply Line may be composed of several stretches of highway connected by one or more Supply Chains.

## 12.4 SUPPLY CHAINS

Off highway, Supply Lines must be composed of *Supply Chains* which are a series of spaced friendly units, each within a specified distance (Supply Range) of another member of the Supply Chain, and with at least one unit of the chain within *Supply Range* of a Supplied Highway or Fortress. Supply Range varies with Road quality, or lack of it:

- **Tracks:** 3 hexes (2 hexes intervening)
- **Trails:** 2 hexes (1 hex intervening)
- **No Road:** every hex (units must be **adjacent** via passable terrain)
- If different types of Road are used, the lesser Supply Range applies.

A single unit **can** contribute to several Supply Chains. Engaged units can form Supply Chains but *Disrupted* units cannot.

## 12.5 SUPPLY INTO BATTLES

Both sides can trace Supply Lines into a Battle. Supply Lines **into** Battle hexes must pass through Friendly Battle Hexsides. Battle Hexsides are friendly to the side that last engaged across them, and control changes **instantly**. Hexsides not crossed by either player are friendly to the defender.

The Defender can trace Supply Lines **through** a battle hex. The Attacker can only trace Supply Lines **into** battle hexes through friendly Battle Hexsides.

**Raiders:** *Unsupplied* units cannot regain a Supply Line (or make a Hexside friendly) by entering Battles via a Enemy Hexside. If the Hexside of entry remains enemy **after** all movement, mark the Raider with a second coin. "Raiders" remain behind enemy lines isolated from friendly Supply.

Raiders fight normally but will become *Disrupted* in the Final Supply Check, unless supply is re-established (e.g., if the battle is won).

## Supply Chains

Supply Chains do not "project" from a unit into the surrounding area, they can only connect to a friendly unit to the next unit in the chain or to the Highway.

*Disrupted* units cannot help form Supply Chains or block Supply Lines.

A Supply Chain cannot be traced from a unit back to itself (e.g., in a loop along Roads). Hexes containing only *Disrupted* units are considered empty hexes for Supply Chain purposes..

## Disrupted Unit Supply

Although *Disrupted* units cannot be used to **form** Supply Chains, they **themselves** can trace supply to any Supply Lines within Supply Range.

## Supply Check Timing Implications

**Unsupplied** units suffer no immediate penalty, but must have a Supply Line (or Fortress/Oasis Supply) at the Final Supply Check to avoid *Disruption* (11.0). Establishing a temporary Supply Line during the turn will not save an *Unsupplied* unit from *Disruption*, it must have a Supply Line at the Final Supply Check.

Therefore, *Supplied* units can interdict enemy Supply Lines by moving to an *Unsupplied* location deep in the enemy rear without immediate ill effect (having been *Supplied* at the Initial Supply Check). Even if they remain *Unsupplied*, these units will not become *Disrupted* until the end of their **next** friendly Player-Turn.

But in the meantime, enemy units that become *Unsupplied* as a result are more immediately threatened with *Disruption*. To avoid *Disruption*, they must recover a Supply Line by the end of **their** Player Turn, which comes **first**.

Note that units can move to *Unsupplied* locations on one Player Turn, and return to a *Supplied* location in the next, **without** becoming *Disrupted*.

**Disrupted** *Unsupplied* units that fail a Final Supply check suffer no additional effect. Units that are still *Unsupplied* when a Month of play ends are **eliminated** and removed from play.

# ROMMEL IN THE DESERT™

## 12.6 SUPPLY NETWORK

The sum of all current friendly Supply Lines is termed the *Supply Network*. When a unit has several valid Supply Lines, **all** of them contribute to the friendly Supply Network.

It is entirely possible for a hex to be in the Supply Networks of both players simultaneously. Opposing Supply Networks may overlap without affecting either side.

## 12.7 SUPPLY CHECKS

### • INITIAL SUPPLY CHECK:

- Check for valid Supply Lines. Determine friendly Battle Hexes and Battle Hexsides. Check for Supply Status of friendly units.
  - Place coin markers on Unsupplied units and remove markers from Supplied units.
  - Mark Fortress Supplied units with a different coin marker.
- Disruption Recovery:
  - Friendly units that have spent a **complete enemy turn** Disrupted but are now Supplied and unengaged revert to their normal, Undisrupted state (turn upright).

### • FINAL SUPPLY CHECK:

- Check for valid Supply Lines. Determine friendly Battle Hexes and Battle Hexsides. Check for Supply Status of friendly units.
- Remove coin markers from any units now in Supply.
- Disrupt all units marked Unsupplied that still have no Supply Line.
  - Immediately Rout newly Disrupted units in Battle Hexes without friendly Shielding units.

**Note:** *Temporarily re-establishing a Supply Line to an Unsupplied unit during the turn will not save it from Disruption if it is Unsupplied in the Final Supply Check.*

### • BUILDUP SUPPLY CHECK:

- Check for valid Supply Lines. Determine the Supply Network of each player: these remain in effect without change throughout Buildup.
- Determine the Supply Status of all units of both sides.
- Eliminate any Unsupplied units.
- Remove coin markers for those units now Supplied.
- Recover all Supplied, Unengaged Disrupted units (turn upright).

### Two More Supply Examples:

**A)** An Allied recon unit moves behind the Axis line and cuts the Highway at Gazala, isolating all Axis forces to the east. During his next turn, the Axis player moves units to Mechili and to Bir Harmat.

These moves re-establish the Highway east from Bir Harmat as an Axis Supply Source because a Supply Chain exists around the blocking unit at Gazala.

The unit at Bir Harmat chains three hexes along the track to the unit at Mechili which chains two hexes along the trail to the Supplied Highway at Derna. No chaining unit is required at Derna.

**B)** Allied units are holding out in Benghazi after main Axis forces have advanced far to the east. The Axis player has some units in the Benghazi hex, attacking the Fortress. As the Attacker, the Axis player cannot trace supply **through** the Benghazi hex so the Highway is blocked at that point.

An Axis unit at Er Regima, would re-establish the Highway east from there as an Axis Supply Source by creating a Supply Chain around Benghazi.

The unit at Er Regima can chain two hexes along the trail/track to the Supplied Highway at Ghemines. No chaining unit is necessary at Ghemines.

## SUPPLY EXAMPLE

Alexandria lies off the map to the east. Allied unit [A] is Supplied along the coast highway. Unit [B] is Supplied along the track (3 hexes) to Mersa Matruh on the coast highway. Other units (not shown on the map) located a further three hexes south at Siwa Oasis would trace a supply line through [B], although one of them would be in supply from the Oasis anyway. Unit [C] is Supplied along a trail (2 hexes) to Sidi Barrani on the coast highway. Unit [D] is Supplied because it is adjacent to [C].

Unit [E] is Unsupplied. It is located in the open desert and it is not adjacent to a Supplied unit. Although it is adjacent to the coast highway (which is usually sufficient to trace a supply line), it is not allowed to trace a supply line through the impassable ridge to the north.

If Axis unit [1] were to move east two hexes and occupy Sofafi, Allied units [C] and [D] would be Unsupplied at the beginning of the next Allied Player-Turn. Axis unit [2] must remain at Sidi Omar to keep Allied unit [D] from being Supplied via Sollum. Allied units [C] and [D] would have to establish new supply lines in that turn to avoid Disruption.

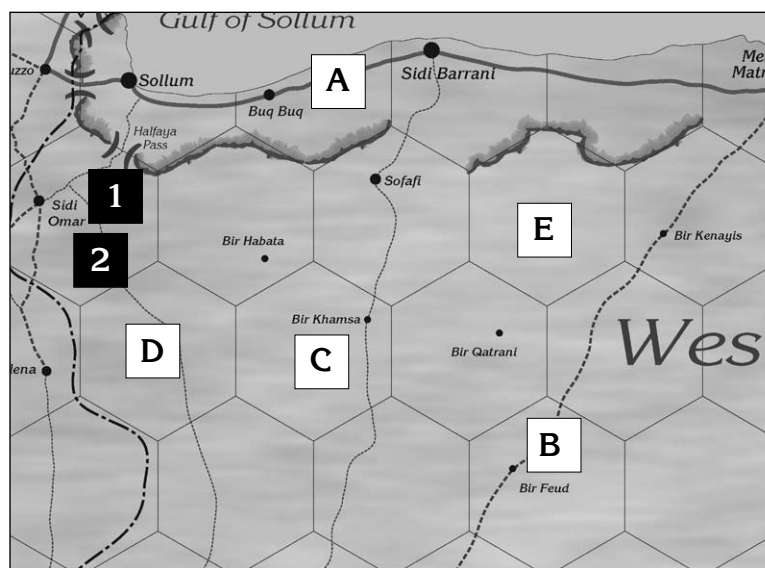



# ROMMEL IN THE DESERT™

## 13.0 FORTRESSES



Benghazi, Tobruk, and Bardia are Fortresses. Special Combat and Supply rules apply to Fortresses.

Fortresses also acts as a ports and Fortress Supply Sources for the side that controls them.

## 13.1 FORTRESS CONTROL

Fortresses are initially *controlled* according to the Initial Deployment areas given at the Scenario start.

Fortress control changes only by Fortress Capture (see 13.4). **An unoccupied Fortress is friendly to the last owner. It is still an empty hex and cannot block supply lines.**

## 13.2 FORTRESS BATTLES

**Defensive Double Dice:** In a Fortress, Defending units (except for armor-class units) fire Double Dice on Defensive Fire. This advantage is lost if the Defender initiates combat.

**Mandatory Combat:** In Fortress battles, the Attacker **must** initiate combat during his own Player-Turn. (Combat is optional for the defender).

**Exception:** *Fortress combat is not mandatory during Blitz Combat*

## 13.3 FORTRESS SUPPLY

**Fortress Supply Capacity.** A Fortress with no land Supply Line to Base is *Isolated*. An *Isolated Fortress* can be used as a Supply Source for a limited number of friendly units equal to its *Port Capacity* (the numbers inside hexagons). The Allies use the **full** Port Capacity shown. For the Axis, Port Capacity is **one-half** this number, rounded **down**.

**Example:** *The Port Capacity of Tobruk is five (5) Allied or two (2) Axis units.*

During each Initial Supply Check, the Active Player may assign available Fortress Supply capacity. Units **inside** the Fortress must receive first priority on Fortress Supply. Other units that can trace a Supply Line to the Fortress may be assigned excess available capacity, but units **nearest the**

**Fortress** must receive first priority for Fortress Supply. Mark units assigned Fortress Supply with coins.

Units assigned Fortress Supply must use the Fortress as their Supply Source throughout that Player Turn: it cannot be negated or switched to another unit (but may be reassigned to different units in a later Player Turns). Units using Fortress Supply may **only** trace Supply Lines (and Withdrawal routes) back towards the Fortress.

Similarly, friendly forces not assigned Fortress Supply cannot trace Supply Lines or Withdraw towards the Fortress (even if located in the same hex as Fortress Supplied units).

If the full Supply Capacity of a Fortress is not utilized in the Initial Supply Check, additional units may be assigned Fortress Supply in the Final Supply Check (within its capacity).

## 13.4 FORTRESS CAPTURE

Fortress control changes only when **Undisrupted** enemy units have sole occupation at the end of a Player-Turn. Passing through a Fortress during Movement is **not** sufficient.

**Captured Supply:** If a Fortress has changed hands during a Month of play, the new owner receives bonus Supply Cards in the following Buildup. The number of cards awarded is equal to **enemy** Port Capacity

**Example:** *The Axis player would receive two (2) bonus Supply Cards for capturing Benghazi, but the Allied player would receive only one (1).*

Captured Supply is never awarded more than once per month for a each Fortress.

## 13.5 BESIEGED FORTRESSES

A Fortress is *besieged* if any hex adjacent to it contains enemy units (is an *enemy hex* or *battle hex*).

Besieging a Fortress affects Sea Redeployment cost (16.53).

Besieging Tobruk can be important to Victory (17.0).

## Fortress Combat in Pass Turns

If the Attacker in a Fortress Battle takes a Pass Turn (e.g., due to lack of supply), Fortress Attackers **must** Disengage by Withdrawal Move, subject to all Disengagement and Retreat rules. If unable to Withdraw during a Pass Turn, the Fortress Attackers are Routed.

## Captured Supply

If a Fortress is captured but recaptured by the original owner in the same month, no bonus supply is awarded.

If captured, recaptured and then captured again, all in the same month, the capturer receives bonus supply just once.

## Fortress Supply Assignment in Final Supply Check Example

The Allied player starts his Player-Turn with two units tracing supply to Tobruk (capacity 5), and has four units unable to trace a Supply Line to Base. If those four units move so that, at the end of the turn, they can trace Supply to Tobruk, then three of those units will be Supplied, and only one will become Disrupted (the one with the longest Supply Line from the Fortress; Allied choice among equally distant units).

However, players may not deliberately withhold Supply from units inside the Fortress. In the example above, the Allies can not leave one of their two units in Tobruk Unsupplied in the INITIAL SUPPLY CHECK, in order to Supply all four of the other units in the final check.

Port Capacity	Axis	Allies
<i>El Agheila</i>	no limit	n/a
<i>Alexandria</i>	n/a	no limit
<i>Tobruk</i>	2	5
<i>Bardia</i>	1	2
<i>Benghazi</i>	1	2

## Fortress Assault Battles

**Non-armor class units attacked in a Fortress with an Assault Battle would have Defensive Fire at Quadruple Dice, and armor units would have Defensive Fire at Double Dice.**

# ROMMEL IN THE DESERT™

## 14.0 MINEFIELDS

During Buildup, Minefields can be secretly built in **unengaged** hexes in the friendly Supply Network (12.6).

Minefields are impartial and may be used by enemy forces if captured.

### 14.1 BUILDING MINEFIELDS

To build a Minefield during Buildup, secretly note the desired location on the **Game Record Sheet** (use a named location or a direction and distance from one, e.g., "El Alamein SW1").

Building a Minefield costs 15 BPs, so it may be necessary to save BPs over several Months to afford one.

### 14.2 MINEFIELD EFFECTS

**Undefended** Minefields have no movement or combat effect. If entered by enemy units, they must be revealed at the end of the Movement phase.

**Defended** Minefields do not affect Movement but have a major effect on Combat. Minefields are not revealed until the end of the movement phase.

In Minefield hexes, the Defender has *Double Defense* (9.52), meaning that Offensive Fire by Attacking units only scores *half-hits*.

**Exception:** *Artillery fire is unaffected by Minefields and scores full hits on defenders.*

It takes **two half-hits** to reduce a defending unit by 1 CV. As for *elite* units, leftover half-hits may be wasted.

**Example:** *Four (4) half-hits are required to reduce an elite unit defending a Minefield by one step.*

The defensive advantage of a Minefield is **lost** if the Defender initiates combat (defending units are considered to have moved out of their "prepared positions" to counterattack). In this case, both sides take normal losses in Combat.

## 15.0 OASES



Jalo, Jarabub and Siwa are Oases. Note the hex distortion at Jalo and Siwa to bring the Oases on-map.

### 15.1 OASIS SUPPLY

Oases cannot act as Supply Sources: units outside Oases cannot trace Supply to them (as Fortresses). A single unit in a friendly Oasis hex, however, is Supplied.

During the Initial Supply Check, **one** unit occupying each Oasis **must** be assigned Oasis Supply. As for Fortress Supply, this cannot be canceled or switched to a different unit during that Player Turn (unless this unit is eliminated).

Units actually **in** the Oasis must receive first priority on Oasis Supply. Players cannot, for example, deliberately withhold Oasis Supply from a unit in an Oasis in the Initial Supply Check in order to apply it to a unit arriving at the Oasis later in the same Player-Turn.

If no unit was assigned Oasis Supply in the Initial Supply Check, Oasis Supply may be assigned to a unit **in** the Oasis at the Final Supply Check.

In Oasis battles only the defending unit receives Oasis Supply; Enemy units need an external supply line.

Units occupying Oases can form part of a Supply Chain as normal.

### Elite Units in Minefields

**Example:** An elite unit defending in a Minefield hex loses one step after it has taken a total of 4 hits. Thus, such a unit would lose a step if it takes a total of 1 hit from artillery and 2 hits from other unit classes in the same Combat Phase.

# ROMMEL IN THE DESERT™

## 16.0 BUILDUP

Each game Month begins with Buildup (except the first, which is factored into starting conditions).

**Exception:** *The Gazala Scenario does begin with a modified Buildup.*

Buildup consists of the following phases, taken in the order shown:

ADVANCE MONTH  
BUILDUP SUPPLY CHECK  
BP DETERMINATION  
FIRST PLAYER BUILDUP  
Reinforcements  
BP Expenditure  
Replacements & Redeployments  
Minefield Construction  
Allocate BPs for Extra Supply  
Resupply (draw all cards at once)  
Monthly Resupply  
Extra Supply (allocated above)  
Bonus Supply (*Fortress Capture*)  
SECOND PLAYER BUILDUP  
(repeat player 1 procedure)

## 16.1 ADVANCE MONTH

During this Phase, advance the turn marker to the next game month.

## 16.2 SUPPLY CHECK

- Check for valid Supply Lines. Determine the Supply Network of each player: these apply **unchanged** throughout Buildup.
- Determine the Supply status of all units of **both sides**.
- Eliminate any Unsupplied units.
- Remove coin markers for those units currently Supplied.
- Recover all Supplied, unengaged Disrupted units (turn upright).

## 16.3 BUILDUP POINT DETERMINATION (BPs)

Each player rolls **two** dice (2d6). (Exception: in the 1940 Campaign, each player rolls **one** die). The total of all four dice is the number of *Buildup Points* received by **each** player.

**Example:** *if one player's dice roll is "9" and the other player's is "7", each player receives 16 BPs.*

The player that rolled the **lower** total is Player 1 for Buildup. If tied, the Allied player is Player 1.

Each player determines current Total BPs available (new BPs for this month plus those previously Saved) and records this on his **Game Record Sheet**.

## 16.4 REINFORCEMENTS

*Reinforcements* are new units that arrive in play during a game. They arrive in the friendly Base during Buildup at **no cost** in BPs.

All Reinforcement units have an expected Month of arrival, as noted on their labels, but **may** arrive one month earlier (see below).

### 16.41 EARLY ARRIVAL

Reinforcement units either arrive in the game month indicated on their counter label (2/3rds chance) or one month early (1/3rd chance).

All Reinforcement units scheduled for the current month that have not already arrived early arrive on time and are deployed in the friendly Base.

Any Reinforcements scheduled for the **next** game Month are checked for *Early Arrival*. The owner rolls one die for each such unit in turn, keeping its identity hidden.

**1-2: Early Arrival.** Unit arrives in Base immediately.

**3-6: Scheduled Arrival.** Unit arrives next Buildup on schedule.

## 16.5 SPENDING BPS

Buildup Points can be spent on the following in any order:

- Redeployments
- Replacements
- Minefields
- Extra Supply Cards

Players can also Save a maximum of 20 BPs for future expenditure. Excess unspent BPs are lost.

**Note:** *Use the Game Record Sheet to record your **own** BP expenditures. If both players agree, opponent expenditures may also be tracked (see sidebar).*

## Early Arrival: First & Last Months

Units can **never** arrive early in the first or last month of a Scenario.

No Buildup occurs in **first** Month of play.

Units cannot arrive early in the **last** Month of a Scenario as that would affect Victory unit counts.

## Early Arrival Example

During Month 2 Buildup (May 1941), all four (4) Allied Month 2 Reinforcements arrive (none can have arrived early in the first month).

The four (4) Axis Month 3 Reinforcements are then each checked for early arrival.

## Reinforcements to an Engaged Base

If a Base is engaged, Reinforcements cannot arrive there, but must wait off board near Base. They are considered a single Group located one hex directly east / west of the friendly Base.

In a subsequent Player Turn, they can only enter the Base by normal Group Move. There are no Hexside limits to enter the Base from this offboard area.

## Game Record Sheet

During Buildup, players note BPs Received, Available, Spent, and Saved, and how BPs are spent on Redeployments, Rebuilds, and Extra Supply cards.

## Divulging BP Expenditures

Upon request, you must divulge to your opponent the number of:

- BPs Saved (from previous Months),
- Redeployments/ BPs spent,
- Steps Rebuilt/ BPs spent,
- BPs spent for Extra Supply,
- BPs spent for Minefields (location is not divulged).

Players can also record enemy steps rebuilt on their **Game Record Sheet**. If enemy losses have been noted during play, the two can be reconciled to help prevent errors in unit strength and/or disputes.

# ROMMEL IN THE DESERT™

## 16.51 REDEPLOYMENT

During Buildup, individual **undisrupted** units can be moved **without reference to Groups** by Redeployments.

One *Redeployment* consists of moving a unit **two hexes** plus all applicable Road Bonuses (the Rommel Bonus is **not** applicable). Each Redeployment costs 1 BP.

**Example:** For 1 BP, any unit can Redeploy 6 hexes along the Coast Highway.

A unit can be Redeployed as many times as desired during Buildup, as long as there are sufficient BPs.

Units being Redeployed must remain **at all times** within the friendly Supply Network (and may not enter the enemy Supply Network where Supply Networks overlap).

Units may never Redeploy into or through battle hexes. Units may Redeploy **out** of battle hexes if at least one friendly unit remains behind. (This is **not** a Disengagement or a Partial Retreat and none of their adverse effects apply).

## 16.52 RETURN FOR REFIT

Instead of Redeploying to Base, **undisrupted** units can *Return for Refit* at **no cost** but then become unavailable to receive Replacements, **or for any other use**, for one Month.

Units being returned to Base for Refit must follow an overland (not sea) route within the friendly Supply Network. The Active Player should indicate the route.

Place such units off-board near the Base, **face-down** (tip backwards to maintain current CV). At the start of the **next** Buildup, Refitted units recover (turn upright and place in Base), and may then receive Replacements and Redeploy normally. (If Base is engaged at this point, treat as for Reinforcements).

## 16.53 SEA REDEPLOYMENT

Fortresses and Bases are also *Ports*. Units can Redeploy by sea between controlled Ports (13.1).

*Sea Redeployment* costs 1 BP per unit, regardless of distance, provided that neither the departing or arrival Port is *besieged* (13.5).

If **either** Port is besieged, *Sea Redeployment* costs the Allies 4 BPs and is **prohibited** for the Axis. *Sea Redeployment* between **two** besieged ports is never allowed.

The maximum number of unit embarkations/debarkations allowed per Fortress during a single BUILDUP is limited to its *Port Capacity* (13.3). Bases have unlimited *Port Capacity*.

*Sea Redeployments* and land Redeployments can be combined.

## 16.54 REPLACEMENTS

Eliminated units are permanently lost, but damaged units can gain CV by receiving Replacements **in Base**.

**Replacement costs:** The sidebar table shows BP costs to increase a unit by **1 CV**. Elite units cost **twice** this amount for a 2 CV step. Units **may** receive multiple Replacement steps, if there are sufficient BPs.

## 16.55 BUILDING MINEFIELDS

During Buildup, players may spend 15 BPs to build a hidden Minefield in any hex within the friendly Supply Network (**not** in battle hexes).

The desired location is secretly noted on the Game Record Sheet. (For hexes with no named location, use a direction and distance in hexes from one, such as "Alamein SW2".)

Two Minefields within the friendly Supply Network may be secretly dismantled, to enable a one new one to be built **immediately** at **no cost**.

## 16.6 RESUPPLY

Collect all Supply Cards **spent** during the previous month (plus any dummy cards players may wish to discard) and return them to the deck.

Shuffle the deck and deal the monthly allotment of Supply Cards to each player (as per Scenario instructions, adding and Bonus Supply (13.4) and Extra Supply purchased during Buildup. A player can never have more than **16** Supply Cards.

## Redeployment

Units can Redeploy to Base, receive Replacements (16.54) and then Redeploy again back to the front (but Redeploying units **cannot** enter battle hexes).

Newly arrived Reinforcements can be immediately Redeployed.

Units can be Redeployed to any hex within the friendly supply network (as determined at the start of Buildup), even if this has the result of incidentally expanding the Supply Network by creating additional Supply Lines. This expansion of the Supply Network is meaningless, as it cannot be applied during the current Buildup.

## Redeployment Example

In a single Buildup, the Axis can Redeploy a unit out of a battle by road to Tobruk, Redeploy it by sea to Base, add Replacements there, Redeploy it by sea back to Tobruk and then by road again toward the front (but it could not enter a battle hex).

## Port Capacity Example

Assuming Tobruk is not besieged, the Allies could move two units **into** and three units **out of** it in a single Buildup, at a cost of 5 BPs. The Axis could only move one unit in and one unit out at a cost of 2 BPs.

## Supply Cards

Players are obliged to reveal the total number of Supply Cards [real plus dummy] in their hands. However, the number of real vs. dummy cards should remain a carefully guarded secret.

## BP COSTS PER CV

Armor & Recon	3
Anti-Tank (all)	3
Artillery (all)	3
Mech & Motor Infantry	2
Leg Infantry & Para	1
<i>Elite Units cost double to increase one step</i>	
Minefields	15
Extra Supply Card	10

# ROMMEL IN THE DESERT™

## 17.0 VICTORY CONDITIONS

The game ends when the stated number of Months for that Scenario (18.0) have been completed.

Listed below in descending order are Levels of Victory that apply to all Scenarios. Higher Levels of Victory overrule lower ones.

Victory Points (VPs) are assigned to each level for tournament purposes.

### 17.1 STRATEGIC VICTORY

A "sudden-death" Strategic Victory is achieved by exiting the enemy map-end with three or more **Supplied** units, or by controlling (1.2) the enemy Base. If either of these conditions occurs, the game ends immediately. **10 VPs**.

### 17.2 DECISIVE VICTORY

Decisive Victory is gained by having **twice** as many units remaining in play at the end of the game as the opponent. **German** units (not Italians or Allied Elites) count as 1.5 units each. **5 VPs**.

### 17.3 POSITIONAL VICTORY

Positional Victory is gained by holding Tobruk at the game's end, **provided** it is not besieged. **2 VPs**.

### 17.4 ATTRITION VICTORY

Attrition Victory is gained by having the larger number of units remaining in play at game's end. **German** units (not Italians or Allied Elites) count as 1.5 units each. **1 VP**.

## OPTIONAL RULES

### ALLIED I-TANKS

The Allied "Army Tank" brigades (1AT and 32AT) consist largely of slow, heavy "Infantry Tanks".

I-tanks have a movement range of 2, instead of 3. They are still elite units (2 hits required to reduce them 1 step).

### Victory Hierarchy Example

A player having twice the unit count of his opponent at the end of the game wins a Decisive Victory even if his opponent is holding Tobruk and it is not besieged (which qualifies for Positional Victory).

### Exiting Units

To exit a unit just move into a mapedge hex and continue moving offboard. You should only exit units if it leads to immediate victory because exited units cannot return.



# ROMMEL IN THE DESERT™

## 18.0 SCENARIOS

Once players agree on a Scenario to play, select the units listed Starting Forces and Reinforcements for that Scenario. Deploy starting forces as directed and arrange Reinforcements in their Month of appearance. Unless otherwise noted, all units begin a scenario at their maximum CV.

The Axis player always deploys first. *Free Deployment* units may be placed in any **Supplied** location in the specified area, not occupied by the enemy.

Then deal the initial allotment of Supply Cards. Players may discard their entire initial hand and redraw a new one (Axis first, then Allies). This may be done only **once**: a redrawn hand must be played.

The Axis player has the first turn in all scenarios and no Initiative Challenge is allowed in the first month.

### 18.1 1940 SCENARIO

**Start:** Sep. 1940 (Month 1)

**Length:** 6 months

**End:** Feb. 1941 (Month 6)

**Time:** 2 hours

#### AXIS STARTING FORCES:

8 Italian units. Free Deployment in **Libya** and **Sidi Omar**.

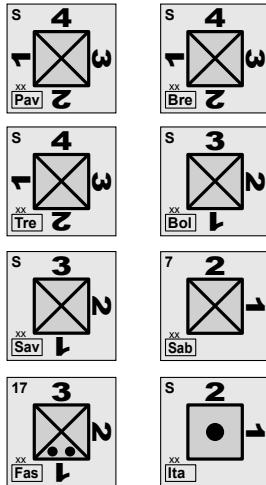

**AXIS INITIAL SUPPLY:** 6 Cards

**AXIS RESUPPLY:** 2 Cards

**AXIS REINFORCEMENTS:**

MONTH 3:

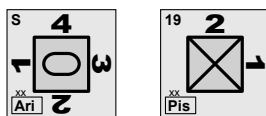

MONTH 5:

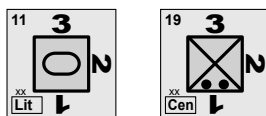

#### ALLIED STARTING FORCES

The following 4 units are deployed using Free Deployment in **Egypt**:

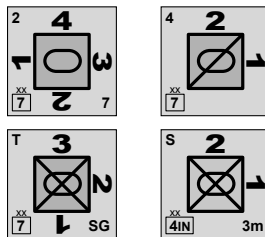

**ALLIED INITIAL SUPPLY:** 3 Cards

**ALLIED RESUPPLY:** 3 Cards

**ALLIED REINFORCEMENTS:**

MONTH 2:

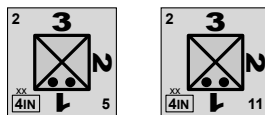

MONTH 4:

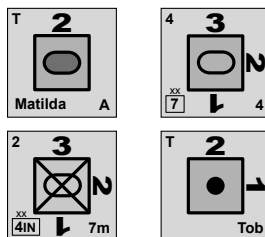

#### SPECIAL SCENARIO RULES

1. The Axis cannot apply the Rommel Bonus in this scenario.
2. Each player rolls only one die (instead of two) for Buildup Points each Month.

#### 1940 Historical Commentary

In September 1940, Britain stood alone: France had fallen, and Russia and America were not yet involved. The Battle of Britain was raging, and Italy had assembled a large army in North Africa to invade Egypt, capture the canal, and turn the British out of the Mediterranean. Britain could not spare forces for Egypt, and the heavily outnumbered British covering force harassed the invaders but fell back under superior pressure. The Italian Army, under Graziani, advanced to Sidi Barrani, and there stopped and fortified. The Italian buildup was slow, and in November the British hazarded a spoiling raid to disrupt the Italian buildup. Graziani's army disintegrated under the shock: half was captured outright and half routed back to the Libyan coastal fortresses. The much more mobile British isolated the two fortresses of Bardia and Tobruk and after a delay, stormed them and captured most of the rest of Graziani's force. The final remnants of the Italians attempted to withdraw to Agheila, but were cut off at Beda Fomm by a daring British move, and annihilated. An entire Italian army of over 150,000 had been wiped out by a British force of 30,000 in less than 4 months. Though the way was clear for a British advance to Tripoli, Churchill instead stripped the front of forces for a pet project: the disastrous expedition to Greece. The stage was set for Rommel.

#### 1940 Strategy Overview

The Italians begin with an advantage in strength and supply, but greatly inferior mobility. The British have an infantry shortage, but gain an armor and supply advantage late in the game. They must put it to good use to regain lost ground, besiege Tobruk, and attrition the Italian Army enough to win.

#### Month of Appearance

Month of appearance codes on the blocks do not apply to the **1940** scenario.

# ROMMEL IN THE DESERT™

## 18.2 1941 SCENARIO

**Start:** Apr. 1941 (Month 1)  
**Length:** 10 months  
**End:** Jan. 1942 (Month 10)  
**Time:** 3-4 hours

### AXIS STARTING FORCES:

**El Agheila:** all "S" units (10 total).

**AXIS INITIAL SUPPLY:** 6 Cards

**AXIS RESUPPLY:** 2 Cards/Month

### AXIS REINFORCEMENTS:

Months 3, 5, 7 (12 units)

### ALLIED STARTING FORCES

Free Deployment in **Libya** and  
**Egypt:** all "S" units (6 units).

**Tobruk:** all "T" units (6 units).

**ALLIED INITIAL SUPPLY:** 6 Cards

**ALLIED RESUPPLY:** 3 Cards/Month

### ALLIED REINFORCEMENTS:

Months 2, 4, 6, 8, and 10 (24 units)

## 18.3 1941-42 CAMPAIGN

This Scenario combines the 1941 and 1942 Campaigns. Starting forces and Initial Supply as well as Resupply are outlined in the 1941 scenario. Standard victory conditions apply.

**Start:** Apr. 1941 (Month 1)

**Length:** 20 months

**End:** Dec. 1942 (Month 20)

**Time:** 6-8 hours

After Month 10, continue playing Months 11-20, making the following changes beginning Month 11:

- Return the Month marker to "1"
- Both players execute a normal Buildup in Month 11. Ignore 1942 Campaign starting deployments: continue playing with the surviving units "as is" until the end of 1942.
- Axis Resupply increases to 3 Cards/Month.
- Axis "M" (Malta Group) units become available as optional Axis Reinforcements (as per the 1942 Scenario rules).

## 18.4 CRUSADER

**Start:** Nov. 1941 (Month 8)

**Length:** 3 months

**End:** Jan. 1942 (Month 10)

**Time:** 1-2 hours

### AXIS STARTING FORCES:

Free Deployment in **Libya, Sidi Omar** and **Sollum:** 22 units total: All Month 3, 5, and 7 units plus all "S" units.

**AXIS INITIAL SUPPLY:** 10 Cards

**AXIS RESUPPLY:** 2 Cards/Month

**AXIS REINFORCEMENTS:** NONE

### ALLIED STARTING FORCES:

Free Deployment in **Egypt** and up to 5 units in **Tobruk** (28 total): All Month 2, 4, 6 and 8 units, plus all "S" and "T" units except:

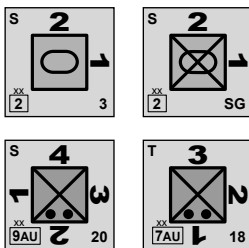

**ALLIED INITIAL SUPPLY:** 12 Cards

**ALLIED RESUPPLY:** 3 Cards/Month

**ALLIED REINFORCEMENTS**

Month 10 (4 units)

### SPECIAL SCENARIO RULES

1. Allies have the first Player Turn (no challenge).
2. Tobruk has a Minefield.

## 1941 Historical Commentary

After the disastrous Italian defeat of the winter of 1940-41, the Axis High Command dispatched Rommel and advance elements of the Afrika Korps to North Africa to stiffen the faltering Italians. Meanwhile the British front had been stripped of forces for the ill-fated expedition to Greece.

Rommel probed aggressively with his meagre force, sensed weakness, and went on the offensive (against orders) out of E1 Agheila around the beginning of April. Skillfully blending bluff, deception, and bold maneuver, Rommel advanced to the Egyptian frontier in less than a fortnight, bypassing Tobruk. Then a hastily-prepared assault on the fortress was sharply rebuffed by the 12,000 Australian defenders.

In the following months, Rommel attacked Tobruk without success, and two British attacks across the frontier failed to relieve the fortress. Both sides dug in and built up strength, the British more rapidly as Africa had become an Axis sideshow during the invasion of Russia.

In November, when Rommel was almost ready for his planned setpiece attack on Tobruk, he was forestalled by "Crusader", the strongest Allied offensive to date. After two weeks of incredibly confused fighting, both sides were exhausted, but it was Rommel who was forced to withdraw due to insufficient strength. He fell back all the way to El Agheila, inflicting some stinging blows on pursuing Allied spearheads. Rommel's first offensive had narrowly failed.

### 1941 Strategy Overview

The Axis has superior quality units, and better mobility, but is short of supply, and must contend with the burden of the attack. The Allies start with a territorial advantage and have a superior flow of reinforcements and supply. Using withdrawals to advantage, the Allies can often accumulate a dominant supply quantity.

# ROMMEL IN THE DESERT™

## 18.5 BATTLEAXE

**Start:** Jul. 1941 (Month 4)

**Length:** 7 months

**End:** Jan. 1942 (Month 10)

**Time:** 2-3 hours

### AXIS STARTING FORCES

Free deployment in **Libya** except **Tobruk** (14 units):

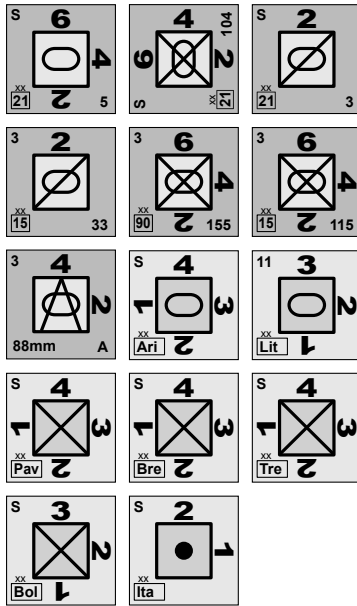

**AXIS INITIAL SUPPLY:** 4 Cards

**AXIS RESUPPLY:** 2 Cards/Month

**AXIS REINFORCEMENTS:**

Months 5 and 7 (8 units)

### ALLIED STARTING FORCES

Free Deployment in **Egypt** and up to 5 units in **Tobruk** (18 units).

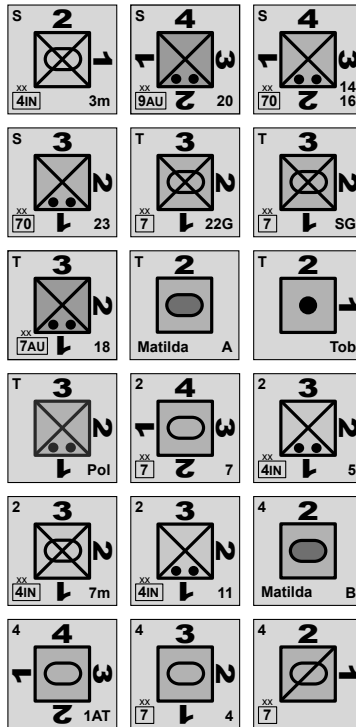

**ALLIED INITIAL SUPPLY:** 8 Cards

**ALLIED RESUPPLY:** 3 Cards/Month

**ALLIED REINFORCEMENTS:**

Months 6, 8, 10 (16 units)

### Battleaxe

This scenario picks up the 1941 Campaign in the 4th Month with Rommel investing Tobruk and holding the frontier. The British have escaped major losses by giving ground, and have accumulated a supply advantage. [This scenario was introduced in a tournament at 'Origins 1987'.]



# ROMMEL IN THE DESERT™

## 18.6 1942 SCENARIO

**Start:** Feb. 1942 (Month 11)

**Length:** 10 months

**End:** Dec. 1942 (Month 20)

**Time:** 4-5 hours

### AXIS STARTING FORCES

**El Agheila:** 14 of the following units below (Axis player's choice).

**Mersa Brega:** 10 of the following units (Axis player's choice):

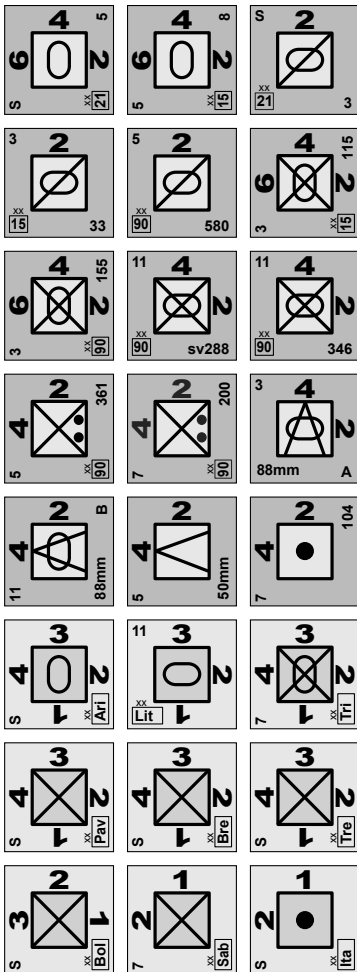

**AXIS INITIAL SUPPLY:** 5 Cards

**AXIS RESUPPLY:** 3 Cards/Month

**AXIS REINFORCEMENTS:**

Months 17, 19 and "M" Units  
(8 units)

**Malta Group:** Axis "M" units are *optional* Reinforcements. They may arrive during any Buildup, but Axis Resupply **immediately** drops to 2 Supply Cards per month.

### ALLIED STARTING FORCES

Free Deployment in **Libya** and/or **Egypt** (10 units):

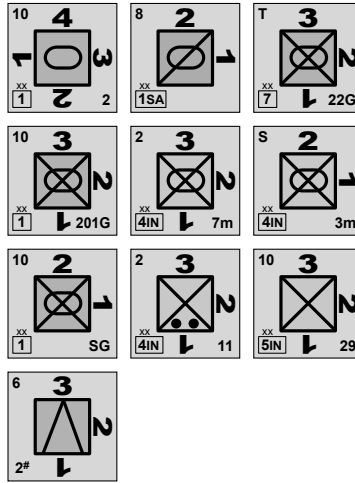

**Tobruk** (10 units):

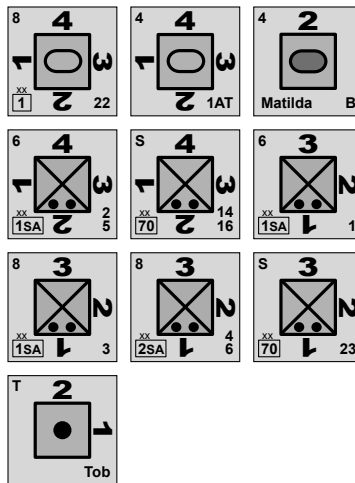

**Alexandria** (8 units):

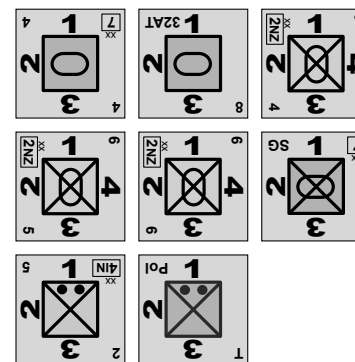

**ALLIED INITIAL SUPPLY:** 5 Cards

**ALLIED RESUPPLY:** 3 Cards/Month

**ALLIED REINFORCEMENTS:**

Months 12, 14, 16, 18 and 20 (24 units)

### 1942 Historical Commentary

After pursuing Rommel back to El Agheila, the British again diverted forces to other MidEast areas. Rommel struck unexpectedly and chased the British back to the fortified "Gazala Line" where he paused. The British were preparing a new offensive but Rommel beat them to the punch, swinging south around the line and driving toward the coast to cut it off.

He was stopped short and trapped behind enemy lines, but the British were slow to take advantage, and he pushed a supply line back through the minefields. British armor finally attacked, but was defeated and then routed by a counterattack.

Rommel once again deceived the Allies by driving past Tobruk in pursuit of British forces, then doubling back at night and taking the fortress. Resupplied with the vast amount of stores in Tobruk, Rommel advanced into Egypt.

After outmaneuvering a British stand at Mersa Matruh, Rommel came up to the partially-prepared Alamein Line, the last (and best) defensive position before Suez. He attacked, but Allied C-in-C (Near East) Aucklenck took direct command and skillfully parried his thrusts.

After weeks of inconclusive skirmishing, both sides dug in and built up. Seeing that the Allied buildup was outpacing his own, Rommel attempted to break through at Alam Halfa in late August, but was foiled by minefields and short supply.

Montgomery completed the massive British buildup before attacking. In late October he opened a relentless battle of attrition against a heavily outnumbered opponent. Rommel returned from sick-leave in time to order a withdrawal, but was countermanded by Hitler.

The British broke through, the Italian forces disintegrated, and the Afrika Korps was shattered. Rommel skillfully extricated the remnants of his mobile forces and escaped but meanwhile the Allies landed in Morocco and Algeria. The Axis was finished in North Africa.

### 1942 Strategy Overview

The Axis has better supply but its strength position deteriorates seriously in time. Again, the burden of the attack is costly in supply. The desirability of rebuilding the depleted Axis force is counter-balanced by the time factor, Allied rebuilding, and the appearance of minefields.

# ROMMEL IN THE DESERT™

## 18.7 GAZALA

**Start:** May 1942 (Month 14)

**Length:** 2 months

**End:** Jun. 1942 (Month 15)

**Time:** 1-2 hours

### AXIS STARTING FORCES:

Free deployment on or **west** of the line: Gazala- Segnali Rotunda- Tengeder- Trigh el Abd- trail southwest to Agedabia (24 units):

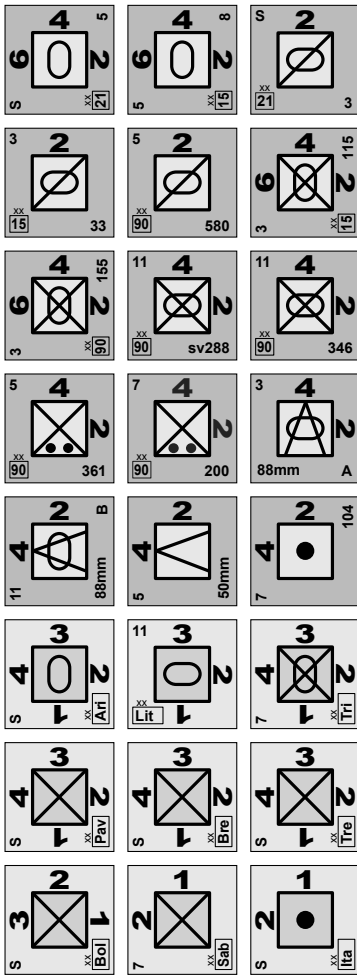

**AXIS INITIAL SUPPLY:** 10 Cards

**AXIS RESUPPLY:** 3 Cards/Month

**AXIS REINFORCEMENTS:** NONE

### ALLIED STARTING FORCES:

Free deployment on or **east** of the line: Acroma- Sidi Mufta- Bir Hacheim- Retma- Bir Guba- the trail to Jarabub Oasis (20 units):

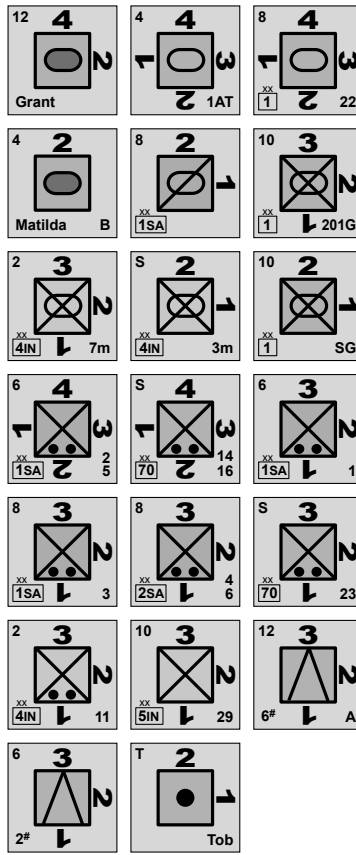

**Alexandria (16 units):**

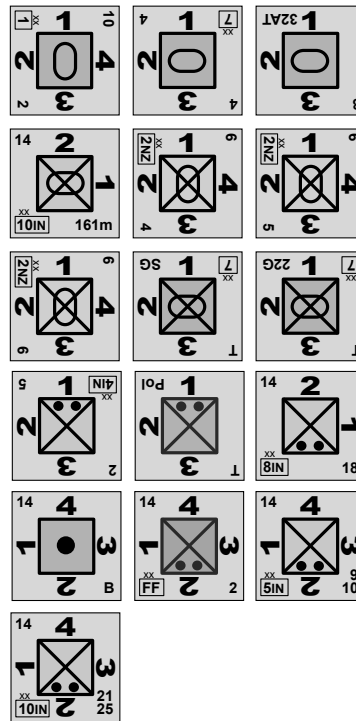

**ALLIED INITIAL SUPPLY:** 12 Cards

**ALLIED RESUPPLY:** 3 Cards/Month

**ALLIED REINFORCEMENTS:** NONE

### SPECIAL SCENARIO RULES

Before initial deployments, do a special PreGame Buildup, with each player receiving 30 BPs (no dice are rolled). The Allied player goes first. These BPs may be spent on Replacements, Redeployments, extra Supply Cards or Minefields as usual. Other Buildups in the game proceed normally.

### Gazala

This scenario begins with the stage set for perhaps Rommel's most remarkable comeback victory of the campaign. His second push towards Tobruk has met a strong Allied perimeter based on minefield boxes, quickly thrown together by the British by transplanting mines from the old Italian Tobruk defenses.

Though the Allies were preparing a counteroffensive, Rommel struck first with the trusty 'right hook' plan. The Afrika Korps outflanked Bir Hacheim and defeated British mobile forces at Retma, but the minefield boxes of the Gazala Line and especially Koenig's stolid Free French at Bir Hacheim held firm. Rommel was trapped behind British lines with no supply.

After British bumbling saved him from utter defeat, Rommel turned the tables, routed the British, and took Tobruk. The British missed a great opportunity here.

# ROMMEL IN THE DESERT™

## 18.8 PURSUIT TO ALAMEIN

**Start:** Jun. 1942 (Month 15)

**Length:** 6 months

**End:** Nov. 1942 (Month 20)

**Time:** 2-3 hours

### AXIS STARTING FORCES

Free deployment in **Libya** (22 units):

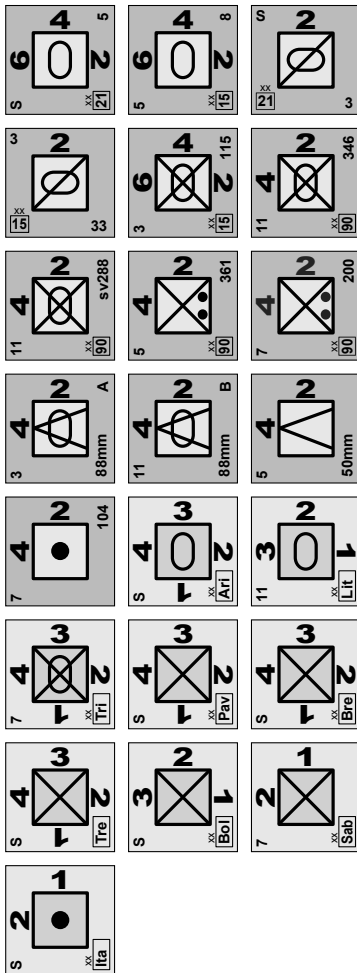

**AXIS INITIAL SUPPLY:** 8 Cards

**AXIS RESUPPLY:** 3 Cards/Month

**AXIS REINFORCEMENTS:**

17, 19 and "M" unit (8 units)

**Malta Group:** Axis "M" units are optional Reinforcements. They may be added during any Buildup, but Axis Resupply immediately drops to 2 cards per month beginning that Buildup.

### ALLIED STARTING FORCES

Free deployment in **Egypt** (16 units):

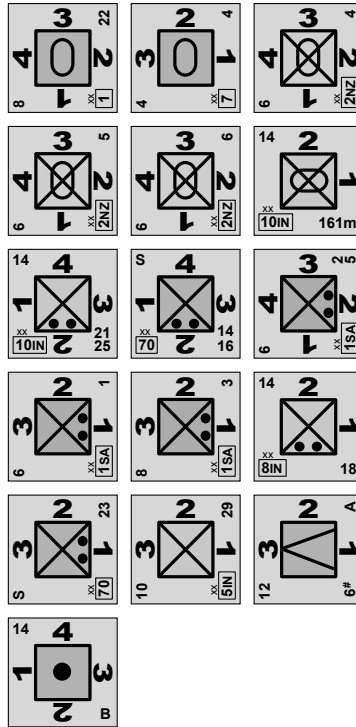

Alexandria (12 units):

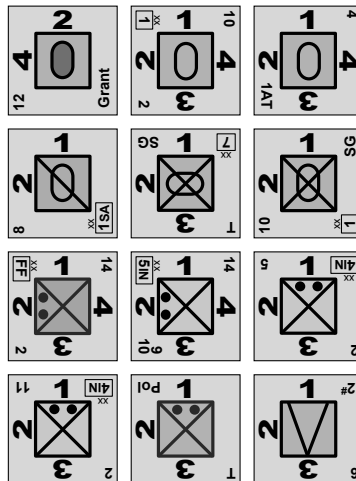

**ALLIED INITIAL SUPPLY:** 8 Cards

**ALLIED RESUPPLY:** 3 Cards/Month

**ALLIED REINFORCEMENTS:**

16, 18 and 20 (16 units)

### Pursuit to Alamein

Beginning one month after Gazala, Rommel has decimated the British army and captured Tobruk with its immense supplies. In the process the Afrika Korps has also taken heavy losses from which it will never completely recover.

Rommel has convinced Axis High Command to abandon the assault on Malta and instead devote airpower and supplies to supporting a lightning pursuit into Egypt. His forces were to prove slightly inadequate to the task but it was "a close run thing." Failure to clear Malta meant increasing Axis supply problems while the British could rebuild rapidly so near their base and hold at El Alamein.

# ROMMEL IN THE DESERT™

## 19.0 DEMO: 1940

### DEPLOYMENT

The Axis player has initially deployed one unit in Bardia, four units in Ft. Capuzzo and three units in Sidi Omar. The Allies have one unit in Sollum, two units in Buq Buq and one unit in Sofafi. Note that units on the movement diagrams are shown with their current CV on the top. The Battle Array diagram shows units facing each other in battle array. The Axis have six Supply Cards, the Allies three.

### GAME MONTH 1: FIRST AXIS PLAYER-TURN

Since this is the first month of the game, the Buildup Sequence is skipped. The Axis spends one Supply Card (a Basic Turn) and makes on regrouping move into Sollum (the Command Point, marked "C", is at Ft. Capuzzo). A maximum of three Axis units can move into Sollum: they are entering an Enemy Hex via the three gaps through the ridge. No other Axis units can move, as no additional units can enter Sollum, the destination hex for the regroup move.

The Allied player now has the option to Refuse Battle and immediately Retreats his Attacked group (only one unit in this case) using a Withdrawal Move. The Allied player chooses to Withdraw to Sidi Barrani. The move is a legal Withdrawal Move because 1) the unit moved back towards its Base along a valid Supply Line (the coast highway) and 2) a forward hex was abandoned, reducing the Supply Network. Neither group has been revealed to the opposing player.

The Retreated unit is Disrupted (for Disengaging) and must take pursuit fire. The Allied player informs the Axis player that the unit (the slowest in the Retreating group) is a mechanized unit. Since the Axis player has no mechanized or faster units involved, there is no pursuit fire. The Disrupted unit is placed face down ("D" in the diagram). There are no Battles, so the Axis Player-Turn ends.

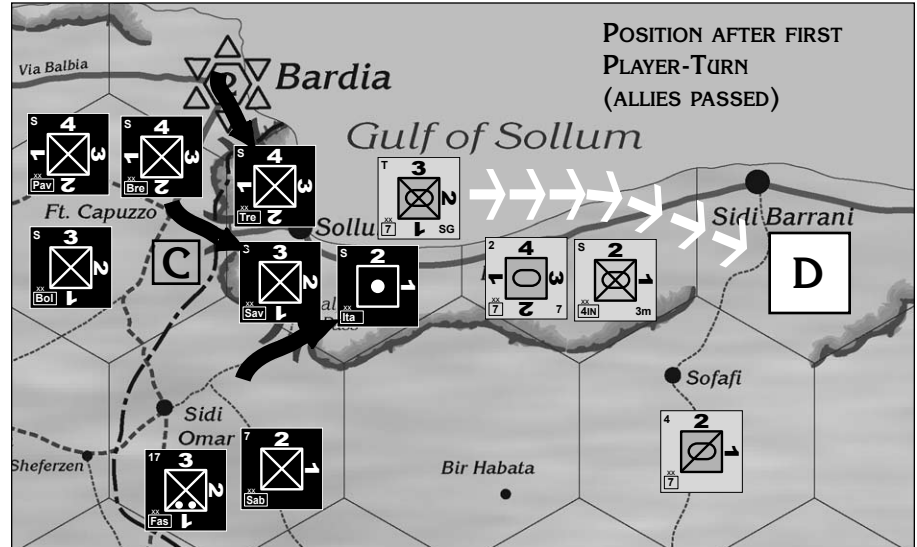

### GAME MONTH 1: FIRST ALLIED PLAYER-TURN

The Allied player passes his turn, not wishing to spend any Supply. The Disrupted unit at Sidi Barrani does not yet recover (it must spend a full enemy turn Disrupted).

### GAME MONTH 1: SECOND AXIS PLAYER-TURN

The Axis plays one Supply Card (Basic Turn) and moves the group out of Ft. Capuzzo. Two units Attack Buq Buq (the maximum allowed through a single Hexside) and the third unit joins the Sidi Omar group.

The Allied player decides to fight this time and has the first fire (Defensive Fire). The armored unit gets two hits with Double Fire (DF) but the mechanized infantry (SF) misses.

The Axis player reduces one of his infantry units by 2 CV (alternatively, both units could have been reduced by 1 CV each).

The Axis player fires both infantry units (4 CV and 2 CV) at single fire (SF), scoring one hit. The Allied player reduces the mechanized infantry unit by 1 CV. The Combat Phase ends.

### BATTLE ARRAY

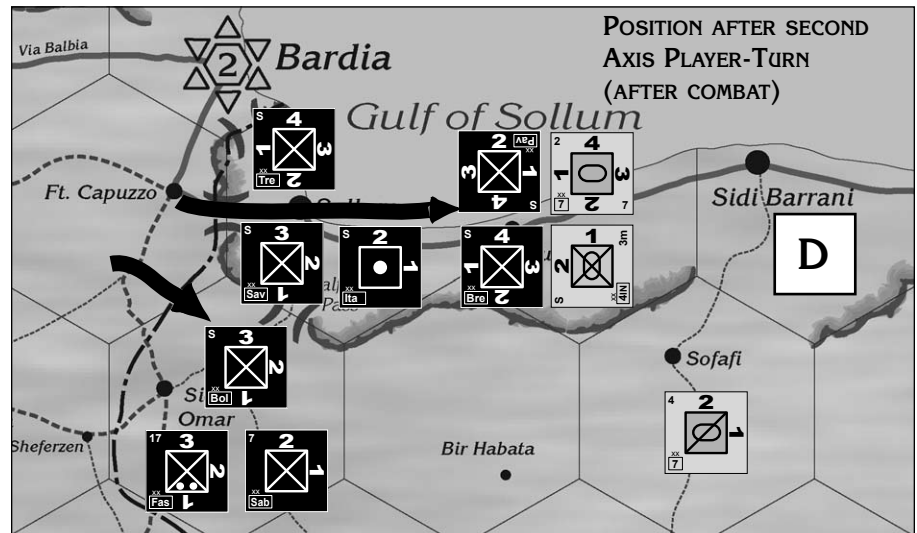
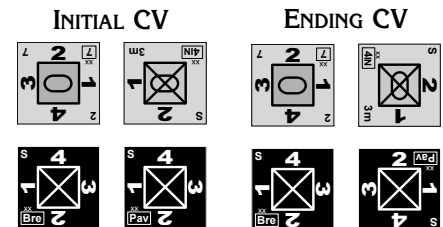

# ROMMEL IN THE DESERT™

## GAME MONTH 1: SECOND ALLIED PLAYER-TURN

The Disrupted unit at Sidi Barrani recovers. The Allied player chooses to Pass to save Supply. One Withdrawal move is permitted on a Pass Turn so the Allied player makes a Regroup Move to the hex east of Sidi Barrani. The Command Point is at Buq Buq (the ridge does not interfere with the Command point). This is a legal Withdrawal Move, since all units involved moved along Supply Lines toward their Base and the Supply Network was reduced.

The units from Buq Buq Retreated from a battle, so they are Disrupted. Since they are faster than the pursuing units, no pursuit fire takes place.

## GAME MONTH 1: THIRD AXIS PLAYER-TURN

The Axis player plays two Supply Cards for an Offensive Turn allowing two Group Moves: 1) two units out of Sollum Attack Sidi Barrani while the third moves to Sidi Omar for Supply chain duty and 2) three units move out of Sidi Omar; two units to Sofafi (the non-motorized unit force marched successfully) while the other moves to Bir Habata for Supply chain duty (chaining Sofafi to Sidi Omar).

The Allied player Withdraws the mechanized unit to Mersa Matruh. Again it takes no pursuit fire, but is Disrupted.

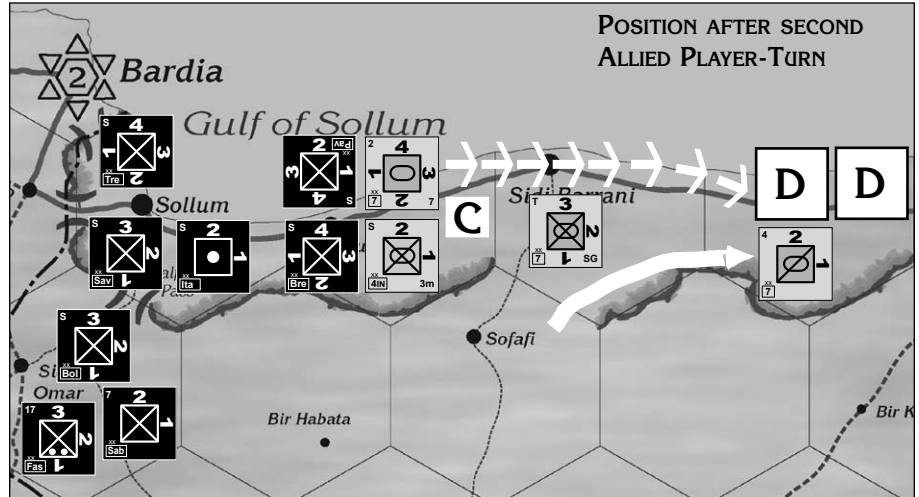

## GAME MONTH 1: THIRD ALLIED PLAYER-TURN

The two Disrupted units west of Mersa Matruh recover. The Allied player passes his turn, not wishing to improve his position.

## GAME MONTH 1: FOURTH AXIS PLAYER-TURN

Having spent four Supply Cards the Axis player also passes his turn, wishing to save the two remaining Supply Cards for future moves. Since both players have passed in consecutive turns, the Month ends.

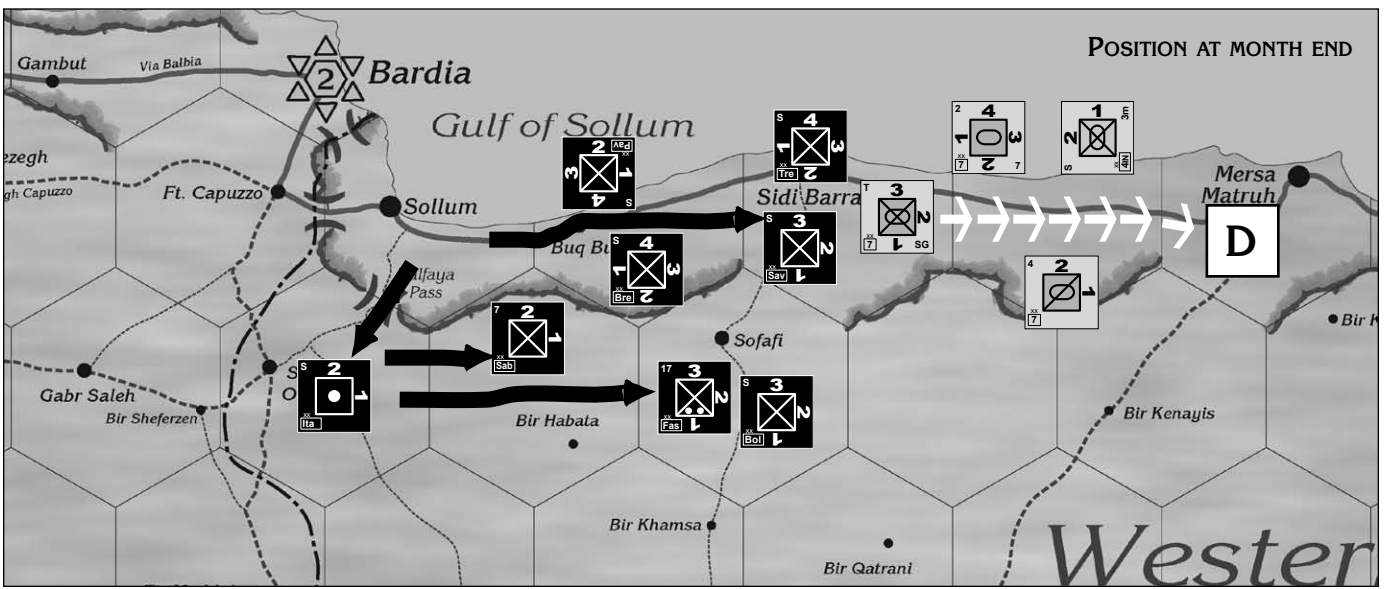

# ROMMEL IN THE DESERT™

## MONTH 2: BUILDUP

The month record marker is advanced to "2". The Disrupted Allied unit in Mersa Matruh is Supplied, so it recovers automatically. Both players roll one die (two dice in other scenarios). The Allied player rolls a "4" and the Axis player rolls a "5"; thus, both players receive 9 Build Points (BPs). The Allied player rolled the lower number, so he spends his BPs first.

The Allied player receives two Reinforcement units at his Base and spends 2 BPs to Redeploy them to the front. He also Redeploys the damaged infantry unit back to his Base (1 BP), rebuilds it 1 step (2 BPs) and Redeploys it again to Mersa Matruh (1 BP). The Allied player saves the remaining 3 BPs.

The Axis player Redeploys his damaged infantry unit at Buq Buq to Bardia (1 BP), moves it by sea to his Base (1 BP), rebuilds it 2 steps (2 BPs) and moves it by sea Redeployment to Tobruk (1 BP). Sea Redeployment back to Bardia was not possible because its Axis Port Capacity (1) was used when the unit was shipped back to Base. From Tobruk the unit is Redeployed to Sofafi (2 BPs). The Axis player saves his last two BPs.

Note that all Redeployments were along Supply Lines only.

After making sure that all expended Supply Cards have been returned to the deck (players can also turn in unwanted dummy Supply Cards) the deck is shuffled. The Axis player then draws two cards, and the Allied player draws three cards.

The Allied player wishes to challenge for the first Player-Turn and places one Supply Card face down. The Axis player declines the challenge and the Allied card is turned face up. It turns out to be a dummy card, so the Axis player goes first anyway. The Axis would have spent a Supply Card for nothing if he had tried to stop the Allied player from taking the initiative.

Buildup for Month 2 is complete, the Axis player takes the first Player Turn.

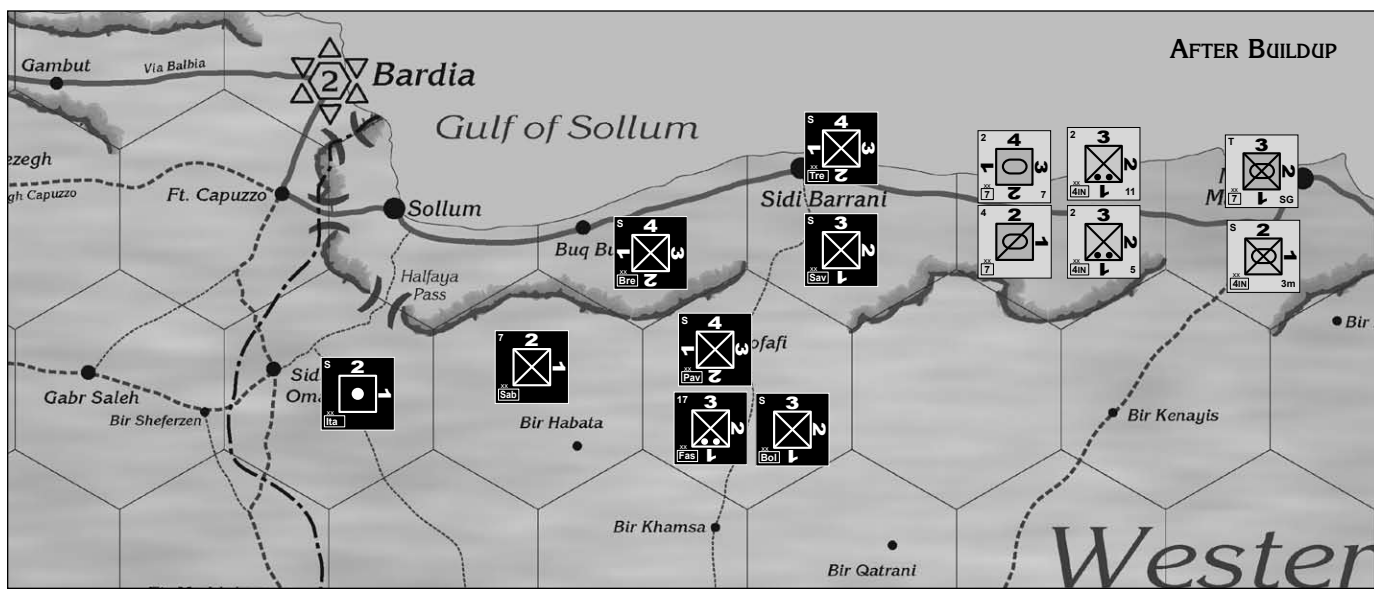

# ROMMEL IN THE DESERT™

## 20.0 STRATEGY NOTES

### SUPPLY LINES

Protection of supply lines must be a primary consideration. To allow the enemy freedom of movement in your rear is to invite disaster; units cut off from supply are likely to become disrupted and quickly overrun.

Accordingly, defensive fronts must be wide enough to prevent outflanking moves and strong or deep enough to withstand a frontal attack.

This implies some dispersion of forces, which is contrary to movement and attack efficiency. Players must constantly strive for an optimum balance between these conflicting demands.

### RESERVES

Because disengaging units are disrupted, it is imperative to maintain a reserve of unengaged units.

Units in battles are effectively pinned; they cannot intervene elsewhere without a costly and time-consuming retreat and reorganization. When all units are engaged, flexibility is lost; there is no way to counter an outflanking move or breakthrough, no way to exploit an opportunity, and no way to retreat safely.

Since battlefield results can be sensitive to small strength differentials, it is often tempting to commit all available forces. However, losing such a battle often means losing the campaign. Without reserve units to cover a retreat, few units will survive the ensuing rout.

### BATTLES

In *Rommel in the Desert*, it is common for several battles to be fought simultaneously. Usually when an army loses any one such battle, its entire position is compromised.

Therefore, an effective tactic is to concentrate on winning just one battle, while "holding the line" in the others. This tactic usually requires a major effort in one battle plus an attempt to attack and pin other enemy groups with smaller forces.

The object is to engage and pin possible enemy reinforcements and generally limit your opponent's freedom of movement. Even when these pinning engagements are fought at a disadvantage, the neutralization of important enemy forces and the constriction of enemy access to battles can be a decisive factor.

Because of the unit-count victory conditions, and the possibility of rebuilding, players should strive to preserve units from elimination: where possible, retire from unfavorable situations early.

### MOBILE DEFENSE

Because of the highly mobile environment and the predominance of offense, counterattack and the threat of it are often more effective than a passive defense.

There is little in the way of defensive terrain on the board, and very few positions when an inferior force can make a stand against a well-supplied opponent. The only truly effective defensive positions are the bottlenecks at El Agheila and Qattara, and those based on minefields.

Minefields are expensive; the timing and location of minefield construction is a crucial aspect of the defensive game, and the one most requiring foresight.

As time and supply are major factors, the player on the strategic defensive must strive to delay enemy advances and extract maximum enemy supply expenditure. Headlong retreats can be easily and efficiently followed up the other player. By maintaining a formidable posture, you can force your opponent to approach cautiously, and well-timed withdrawals can leave the enemy striking at air.

However, this mobile defensive strategy is easier to describe than to execute; it requires care in planning. In particular, careful consideration should be given to the preparation of viable "fallback" lines that can be manned with maximum movement efficiency.

### STATIC DEFENSE

When standing on the defense, several philosophies are viable. The best choice depends on considerations of geography, strength, supply balance, and time. Three basic defensive alignments are described below:

- **Linear Defense** (a strong front line) is good with regard to attrition, but invites outflanking, which is always possible except at the board-end bottlenecks. This defensive style implies a weak reserve and is inflexible and brittle, with little offensive threat. However, this type of defense becomes more attractive with good strength and defensive position.

- **Defense-In-Depth** provides good security against possible Blitzes. However, the resulting dispersion of force has obvious movement and combat disadvantages. This defense is effective in extracting enemy supply expenditure, but is very costly in friendly unit attrition compared to enemy losses.

- **A Strong Central Reserve** provides maximum flexibility and offensive threat, at the cost of a weakened forward wall, exposing frontline units to (initially) disadvantageous engagements. The ability to either counterattack strongly or retreat in good order from this alignment is a major advantage. However, the forward line should not be weakened to the point where a successful Blitz could penetrate, allowing engagement of the reserve, which would negate all the advantages of this deployment.

### OFFENSE

In general, the player on the offensive should seek to apply and increase pressure on the opponent through rapid and unexpected maneuvers, multiple threats, high-powered turn options, and pinning engagements. The goal should be to cause the opponent more problems than he can solve in one turn.

# ROMMEL IN THE DESERT™

Maintaining this pressure will force your opponent to react to pressing short-term threats with increasingly inefficient responses, unable to pursue his own objectives or prepare for your next move.

Concentration of force is highly desirable for striking power, moderated of course by defensive and supply needs. When planning moves, the future implications of dispersion should be considered. It is advisable (but not always possible) to maintain some concentration of force for immediate use. Apart from the obvious movement and combat advantages of concentration, it takes time to regroup a dispersed army, and in the meantime, pressure on your opponent is relaxed.

## 21.0 DESIGN NOTES

*Rommel in the Desert* includes the all-important **psychological** factors of strategy, so crucial in the historical campaign and so often overlooked in most wargames. Factors like surprise and deception, bluff and nerve are not merely good gaming features, but ultimately **necessary** to explain what happened in the Western Desert.

This game also reflects command problems more realistically by forcing the necessity for compromise under organizational and time constraints.

### THE UNITS

It should be understood that the CV assigned to units in the game is meant to represent just that, their Combat Value. Numbers of men, and quality and quantities of equipment do not begin to tell the whole story about the effectiveness of a military formation in battle. Such factors as leadership, training and morale have as much or more impact on "combat value" than mere numbers.

While some military units have continued to function after sustaining over 80% casualties, others have surrendered or disintegrated before suffering 10% losses. Such units must be considered to have been reduced to ZERO combat value, even though their manpower and equipment may be virtually intact.

Even a cohesive formation of tough and determined soldiers may have limited combat value due to poor communications, faulty doctrine, inadequate weaponry, insufficient mobility, or bad leadership.

Certain 'technological' armor and anti-tank units have been included in the game to reflect the sudden leaps in effectiveness achieved by existing forces with the introduction of new and superior weaponry.

The Allied Order of Battle has been modified to eliminate the historical "comings and goings" of units in the game. The correct number and type of brigades is preserved, but the historical designations (which are for interest only) of units in play may at times be incorrect, with one historical unit substituting for another. This eliminates the unproductive shuffling of units in and out of the game.

For example, in many cases a historical unit left the campaign at a certain point and was replaced by a similar unit. In this game the original unit remains in play, representing the unit that replaced it in the Allied OB. Note that units arrive in the game on the basis of their historical appearance **at the front**, as the Allies tended to keep new units in rear areas for months of training and acclimatization.

See the table in the next column for details.

## Unit Substitution

Game Unit	Period	Historical Unit
4 Ind/5	Mar-Jun '40	6 Aus/15
4 Ind/11	Mar-Jun '40	6 Aus/17
4 Ind/7 Mot	Mar-Jun '40	6 Aus/19
4 Ind/7 Mot	Feb '42-	5 Ind/10
4 Ind/3 Mot	Apr '42-	10 Ind/25*
4 Ind/5	May '41-	1 SA/5*
70/23	Jan-Jun '41	9 Aus /24
70/23	Dec '41-	50/150
70/14+16	Jan-Jul '41	9 Aus /26
70/14+16	Dec '41-	50/151*
7 Aus/18	Jun '41-	2 SA/6*
9 Aus/20	Jul-Dec '41	70/16 *
9 Aus /20	Jan '42-	50/69
Pol	Oct '41-Jan '42	1 FF
Pol	Jan '42-	(2 FF)
7/7 Tk	Nov '41-	(CRUS)
2 NZ/4	Dec '41-Jan '42	161 Ind Mot
2 NZ/5	Dec '41-Jan'42	5 Ind/9
2 NZ/6	Dec '41-Jan'42	5 Ind/10*
22 Gd	Jun '42-	44/133*

\* Co-identified units

( ) Units not identified in game



# ROMMEL IN THE DESERT™

## MOVEMENT

Group movement is a simple and effective mechanism to reward foresight and planning in the concentration and organization of forces. Commanders could not ALWAYS execute perfect maneuvers involving far-flung forces. To say that the movement limitations imposed by the system are unrealistic in the era of modern communications is to miss the point. The opponent's communications are just as fast; he can react before a commander can move all his forces and that is precisely the effect of the group movement system.

By limiting the amount that can be done at one time, group movement also emphasizes the "use of time" (or tempo), the idea being to cause the opponent problems which will occupy his time while you are causing further problems. Rommel's natural instinct for this technique was most effective in an environment like the desert, where events develop quickly, and was a key element of his success. The ability to shift gears with high-powered but expensive multiple-move turn options allows further opportunities to upset enemy expectations.

## COMBAT

The combat system in the game is also unique. Unlike most combat systems, it favors the defender only slightly, as did desert warfare. The desert provided little in the way of physical or visual cover, mobility was basically unrestricted, unit density was very low, and the inland flank was always hanging. North Africa was in fact the perfect environment for a counterattacking "mobile defense"; fixed infantry defenses were basically useless unless extensively fortified.

Realistic combined arms effects are integral to the combat system. The mathematics of combat may seem simple but in fact they produce two sophisticated effects: a skewed bell curve for expected attrition; and the "acceleration effect" of fire superiority, where firepower differentials tend to widen in time.

The combat system yields a wide variety of results, in which no level of superiority can guarantee success. In battle, things rarely go as expected. Real commanders cannot assume that what should happen will, or that what shouldn't happen won't. They don't have the security of knowing the true "combat value" of their troops, or of consulting a "combat results table". In *Rommel in the Desert* players are subject to the same lack of certainty.

## BATTLES

Extended engagements require players to manage battles, rather than simply initiating them and then accepting a given result on a single die roll. As battles develop, the questions of when to retreat, when to hold, and when and where to commit reserves fall upon the commander.

The retreat rules are designed to reflect the difficulties of extricating engaged forces in a mobile environment and to emphasize the importance of reserves. A player without unpinned reserves in this game is militarily bankrupt, powerless to react to the moves of his opponent.

## SUPPLY

Supply lines in the game are critical. Players who ignore this will find themselves with an army of disrupted units that will melt before an enemy advance.

The chaining of units along tracks and trails reflects the problems of lengthy supply lines through difficult terrain and the need for more and more support units at the expense of combat units.

The supply cards represent not only supplies, but also control time and the turn options. The variable length of months and the choices of turn options reflect the "stop-go" nature of the campaign and allow directed supply effort. The Basic Turn is the most efficient use of supply (there are diminishing returns on higher options) but well-executed use of the high-powered options will upset your opponent's best laid plans.

A small but well-supplied army is more than a match for a stronger but poorly-supplied one. The secrecy of supply levels provides magnificent opportunities for deception and nerve. Bluff can sometimes carry the battle on shoestring supply, especially against a rattled or demoralized opponent, but the threat must be credible.

## VICTORY CONDITIONS

The victory conditions involve both attrition and position. Their relative values are rated by VPs.

Awarding a decisive victory for having a 2:1 advantage in units remaining at the games' end is a recognition of the inevitability of a strategic win with this superiority of strength, given more time and supply. The lesser victory conditions center around Tobruk. Although this fortress had some military value, the essential benefit in holding Tobruk was its status as the best defensible port in a region where everything from fuel to food to ammunition, and even water had to be imported. For this reason the victory conditions recognize no value for possession of Tobruk if the port is besieged and hence not fully active.

# ROMMEL IN THE DESERT™

## INDEX

Active Battles .....	8.6	Hexside Limits.....	7.1	Strategy Notes .....	20.0
Active Player .....	3.4	Highway Supply.....	12.3	Supply .....	12.0
Applying Losses.....	9.5	Initial Supply Check.....	12.7	Supply Checks .....	12.7
Assault Turn.....	4.3	Initiative.....	3.3	Supply Chains.....	12.4
Attacker.....	8.3	Minefields.....	14.0	Supply into Battles .....	12.5
Attacks .....	8.2	Month .....	3.1	Supply Lines .....	12.2
Attrition Victory .....	17.4	Movement .....	5.0.	Supply Network.....	12.6
Base.....	1.6	Nationality .....	2.1	Supply Source.....	12.0
Basic Turn .....	4.1	Oasis .....	15.0	Targeting.....	9.3
Battle .....	8.0	Oasis Supply.....	15.1	Terrain .....	1.4
Battle Array.....	8.5	Offensive Turn.....	4.2	Turn Option.....	4.0
Battle Hexsides.....	8.1	Overrun.....	11.4	Unit Type and Class.....	2.2
Besieged .....	13.5	Passive Player.....	3.4	Unsupplied .....	12.1
Blitz Turn .....	4.4	Partial Retreat .....	10.4	Victory Conditions.....	17.0
BPs / Buildup Points.....	16.3	Pass Turn .....	4.5	Withdrawal Move .....	5.3
Buildup.....	16.0	Player Turn .....	3.4		
Buildup Supply Check.....	12.7	Port Capacity.....	13.3		
Combat.....	9.0	Positional Victory .....	17.3		
Combat Rounds .....	9.1	Probe Combat.....	10.41		
Command Point .....	5.2	Pursuit Fire.....	10.5		
CV / Combat Value.....	2.3	Raider.....	12.5		
Decisive Victory.....	17.2	Rearguard.....	10.4		
Defender.....	8.3	Redeployment.....	16.51		
Designer's Notes .....	21.0	Refusing Battle .....	8.4, 10.2		
Disengagement .....	7.2	Regroup Move .....	5.2		
Disruption .....	11.0	Reinforcements.....	16.4		
Disruption Recovery .....	11.2	Replacements .....	16.54		
Double Defense.....	9.52	Resupply .....	16.6		
Double Dice .....	9.21	Retreat .....	10.0		
Double Fire.....	9.4	Retreat Routes .....	10.1		
Elite Unit .....	2.4	Return for Refit.....	16.52		
Final Supply Check.....	12.7	Roads .....	1.5		
Firing Units .....	9.2	Road Bonuses .....	6.2		
Firepower .....	9.4	Rommel Bonus.....	6.3		
Forced March .....	6.4	Rout .....	11.3		
Fortresses.....	13.0	Sea Redeployment .....	16.53		
Fortress Capture.....	13.4	Sequence of Play .....	3.0		
Fortress Supply.....	13.3	Shielding Units .....	11.11		
Full Retreat.....	10.3	Speed .....	6.1		
Group .....	5.0	Stacking .....	1.3		
Group Move.....	5.1	Step.....	2.3		
Hex Control .....	1.2	Strategic Victory.....	17.1		

# GAME RECORD SHEETS

OPPONENT NAME:					DATE:						
TURN	1	2	3	4	5	6	7	8	9	10	
BP <sub>s</sub> Saved Previous Turn											
+ BP <sub>s</sub> Received This Turn											
= BP <sub>s</sub> Available											
- Replacements											
- Redeployments											
- Minefields (15 BP <sub>s</sub> )											
- Extra Supply Cards (10 BP <sub>s</sub> )											
= BP <sub>s</sub> Remaining <small>(carry to next column)</small>											

OPPONENT MINEFIELDS #1  #2  #3

YOUR NAME:					DATE:						
TURN	1	2	3	4	5	6	7	8	9	10	
BP <sub>s</sub> Saved Previous Turn											
+ BP <sub>s</sub> Received This Turn											
= BP <sub>s</sub> Available											
- Replacements											
- Redeployments											
- Minefields (15 BP <sub>s</sub> )											
- Extra Supply Cards (10 BP <sub>s</sub> )											
= BP <sub>s</sub> Remaining <small>(carry to next column)</small>											

----- Fold back along this line -----

YOUR MINEFIELDS #1  #2  #3

# ROMMEL IN THE DESERT™

## THE GAME MONTH

- BUILDUP (except first Month)
- INITIATIVE CHALLENGE
- FIRST PLAYER-TURN
- SECOND PLAYER-TURN

## BUILDUP SEQUENCE

- ADVANCE MONTH
- BUILDUP SUPPLY CHECK
- BP DETERMINATION
- FIRST PLAYER BUILDUP
  - Reinforcements
  - BP Expenditure
  - Replacements & Redeployments
  - Minefield Construction
  - Allocate BPs for Extra Supply
- Resupply (draw all cards at once)
  - Monthly Resupply
  - Extra Supply (allocated above)
  - Bonus Supply (*Fortress Capture*)
- SECOND PLAYER BUILDUP
  - (repeat player 1 procedure)

## PLAYER-TURN SEQUENCE

- INITIAL SUPPLY CHECK
  - Determine Unit Supply
  - Disruption Recovery
- TURN OPTION SELECTION
  - Supply Commitment (hidden)
- MOVEMENT
  - Group/Regroup Move(s) [R\*]
  - Retreats (Full and Partial)
    - Probe Combat (if Partial)
  - Pursuit Fire (Retreating units)
  - Move/ Disrupt Retreating Units [R\*]
  - Forced Marches
  - Refuse Battle (Passive Player)
  - Pursuit Fire
    - Withdrawal [R\*]
- COMBAT (not Pass Turn)
  - Active Battles
    - Defensive Fire [R\*]
    - Offensive Fire [R\*]
- BLITZ MOVEMENT (Blitz Turn)
  - (as MOVEMENT)
- BLITZ COMBAT (Blitz Turn)
  - (as COMBAT)
- FINAL SUPPLY CHECK
  - Disrupt Unsupplied units [R\*]
- SUPPLY CARDS REVEALED

- [R\*] ROUT POSSIBLE (Interrupts Play)
  - Rout Attrition
  - Pursuit Fire
  - Withdrawal Move
  - Continue Play

## FIRE TABLE

		TARGET UNIT				
FIRING UNIT				DF	SF	
			SF		DF	
			SF		DF	
			DF	SF	SF	
			SF*	DF*	DF*	SF*
			<b>REQUIRED TARGET</b>		<b>HITS</b>	
		*	<b>MUST FIRE FIRST</b>		SF: 6	
			<b>ONLY IF UNSUPPORTED</b>		DF: 5,6	
					TF: 4,5,6	

## BP COSTS PER CV

Armor & Recon	3
Anti-Tank (all)	3
Artillery (all)	3
Mech & Motor Infantry	2
Leg Infantry & Para	1
<i>Elite Units cost double to increase one step</i>	
Minefields	15
Extra Supply Card	10

## TURN OPTIONS

	BASIC	MC
	OFFENSIVE	MMC
	ASSAULT	MC*
	BLITZ	MC + MC
No Cost	PASS	(W)

**M** = Move Phase   **C** = Combat Phase  
 \* Any/All battles can be Assaults.  
**(W)** = 1 optional withdrawal move