

®

# STOP THE COPS

## ELECTRONIC COPS AND ROBBERS

For 2 to 4 Players/Ages 10-Adult

 **PARKER  
BROTHERS**

Rules © 1979 Parker Brothers, Beverly, Mass. 01915. Printed in U.S.A.

## EQUIPMENT

1 Game Board • 2 Dice • 4 Playing Pieces, each a different color • 8 Detective Licenses • 10 WANTED Posters • 32 Sleuth Cards • Reward Money • ELECTRONIC CRIME SCANNER™

## TECHNICAL INFORMATION

### 1) **PROPER CARE**

The electronic unit's computer brain is made of many delicate parts. Therefore:

- Never take your CRIME SCANNER™ apart.
- Don't drop or jolt your CRIME SCANNER.
- Take care not to get your CRIME SCANNER wet.
- Don't use a pen or pencil to press the buttons on your CRIME SCANNER; use your fingers *only*.

### 2) **BATTERY**

Your CRIME SCANNER is completely portable when powered by a 9-volt battery. We strongly recommend that you use only an **ALKALINE BATTERY**; it will last much longer than a regular carbon battery.

### 3) **BATTERY INSTALLATION**

- a) The battery cover is the outlined area on the bottom of the game.
- b) To remove the cover, place your thumb on the grooved square. Then slide the cover toward you and lift it off.

**PLEASE READ THIS SECTION CAREFULLY.**

c) Install the battery (+ and -) *exactly* as shown in the accompanying diagram. If you don't, you may damage the unit permanently. Also be sure to place the battery so it covers all the wires. And make sure that each battery clip is securely fastened.

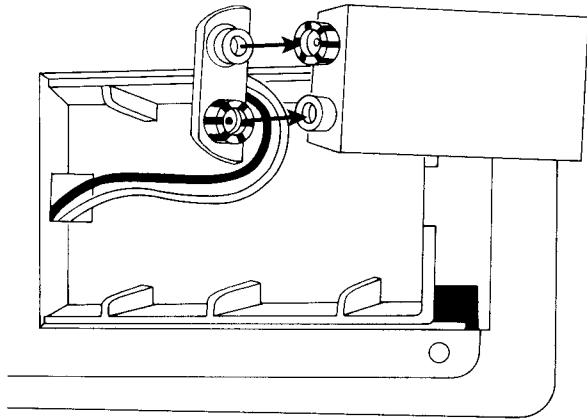

d) To replace the cover, first align it flush against the compartment opening. Then slide the cover securely into place.

#### 4) **BATTERY CARE**

To extend the life of the battery, always remove it when storing the game for long periods of time.

To prevent battery leakage—and consequent damage to the unit—*immediately* remove any battery that you suspect to be defective.

#### 5) **BATTERY REPLACEMENT**

All batteries must eventually be replaced. Therefore, *if you ever find that your CRIME SCANNER is not working properly, you probably need a new battery.* A weak battery, for example, may cause a continuous buzzing sound; as the battery gets weaker, the buzz gets louder. If this happens, replace the battery.

If any problems occur with a new battery, check to make sure that you've installed it correctly.

# OBJECT

makes on the board. With your **CRIME SCANNER** you can hear the thief in the very act of committing a crime. You hear him, too, as he crosses a squeaking floor; opens a creaking door; breaks the glass in a window; runs along the street; or tries to escape on the subway.

Each sound you hear on your **CRIME SCANNER** provides you with a clue to the thief's location on the board. By carefully using these sound clues, you can track down the thief and close in for an arrest. You then use your **CRIME SCANNER** to call the cops and direct them to where you think the thief is on the board. With a little luck, the cops will arrest the thief and cart him off to the station for booking.

After this thief is arrested, other thieves will also steal. Each thief works alone; each is invisible; each carries a reward.

**Your challenge:** to be the first detective to earn \$2,500 in Reward Money.

You and your opponents are licensed private detectives, assigned to track and arrest a notorious thief. The detective who makes the arrest will earn a reward of at least \$800.

The thief, however, is unlike any you've ever pursued: he's computer controlled and completely invisible.

But you can hear him! Each time the thief makes a move on the board, he triggers a sound on your **ELECTRONIC CRIME SCANNER**. This remarkable device follows every move that the thief

## THE BOARD

As you can see, the board is a city block of buildings, streets and subway stations. Within this scene are 19 locations—marked in red—where a thief can commit a crime. Of these possible crime locations only the NEWSSTAND is outdoors. The rest are in the various buildings: FURS—Building 1; JEWELRY—Building 2; ANTIQUES—Building 3; and the BANK—Building 4.

When the game begins, a thief is in the act of committing a crime at one of these 19 locations. To earn a reward, you must arrest him before one of the other detectives does. But first you have to track him down using the sound clues you hear on your ELECTRONIC CRIME SCANNER.

## CRIME SCANNER

**SAMPLE SEQUENCE OF SOUNDS**  
*During a regular game, each sound clue relates directly to a thief's exact location on the board. Now, however, listen to the sound clues just to become familiar with them.*

Each of the sound clues is different. To hear what they sound like, first press the ON button. **Press it once, quickly and lightly; do not hold it down.** Three dashes (---) should appear on the Display. If so, continue. If not, press OFF, wait about 60 seconds, then press ON.

**CLUE.** Now press the CLUE button and you'll hear a thief committing a crime. On the Display you'll see the number of the Building (1,2,3,4) or Street (5,6,7,8) where the Crime (C-R) is taking place.



**To hear the rest of the sample sound clues,**

Sound Clue	Display
<b>Press CLUE:</b> The thief crosses a FLOOR	FL
<b>Press CLUE:</b> The thief opens a DOOR	dr
<b>Press CLUE:</b> The thief breaks the GLASS in a window	GL
<b>Press CLUE:</b> The thief runs along the STREET	St
<b>Press CLUE:</b> The thief rides on the SUBWAY, then returns to the STREET	St

During a regular game, the thief will do whatever he can to throw you off his trail. So sometimes he doesn't move at all when you press CLUE. If he doesn't move, you won't hear a sound clue. Instead you'll hear only a single "bleep" and will see the previous clue flashing on the Display.

**TIP.** Once in a while—thanks to a Sleuth Card—you won't have to rely completely on sound clues to track the thief. Instead you'll be able to call the Tipster. The Tipster is in cahoots with the thief and therefore always knows exactly where the thief is hiding. To get this information from the Tipster, you'll probably have to pay him some cash; but you'll find that it's usually worth the expense in order to stay a step ahead of the other detectives.

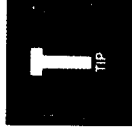

**Press TIP and hold it down:** The Tipster squeals on the thief and shows you—on the Display—the thief's exact location. Just remember, a tip is secret information; be sure to hide the Display when the tip appears. Remember, too, to hold the TIP button down; as soon as you lift your finger, the tip will disappear from the Display.

**ARREST.** You also use your CRIME SCANNER to try to make an arrest. As you'll discover, an arrest can be *successful, false or unsuccessful.*

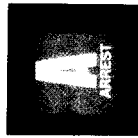

To hear the different arrest sounds,

**Press ARREST:** The cops arrive with sirens wailing, fire warning shots, and arrest the thief. Then, with a "hee-haw" siren, the cops cart the thief off to the station for booking. A **successful** arrest.

**Press ARREST:** After you hear the sirens, you hear the thief give the cops a "raspberry." He does this when you try to arrest him in the wrong place. (Even the best detectives sometimes make mistakes!) A **false** arrest.

**Press ARREST:** After the sirens and warning shots, the thief laughs at the cops with a "NA-na-na-na-NA-na!", and then escapes. An **unsuccessful** arrest.

If you want to hear the CLUE, TIP and ARREST sounds again, press the same buttons again.

**When you think you're familiar with the different sounds, press the OFF button.**

## SET UP

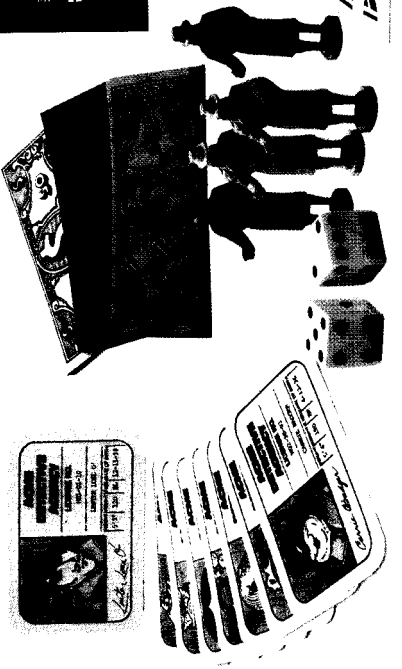

1) Each player takes a Detective License. There are four Licenses for male detectives and four for female detectives.

2) Each detective chooses a playing piece and places it onto the ACME DETECTIVE AGENCY.

3) Shuffle the Sleuth Cards and deal 3, face down, to each detective. Place the rest of the cards—the *draw pile*—face down next to the board. During the game, each detective may look only at his or her own cards.

4) Choose a detective to be the Banker.

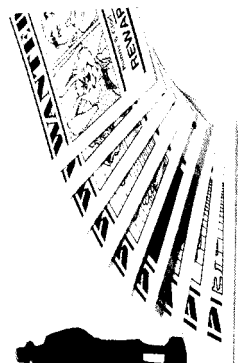
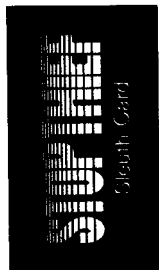

- a) The Banker separates the money by denomination into different piles. These piles form the Bank. During the game, the Banker must be careful not to mix his or her money with the Bank's money.
  - b) The Banker shuffles the WANTED Posters and places them, face down, next to the Bank money. He or she then turns over the top WANTED Poster (the first thief), covers it with the appropriate amount of Reward Money and places it next to the board.
  - c) The Banker hands \$300 to each detective—2 \$100 bills and 2 \$50 bills.
- 5) Each detective rolls the dice. The one who rolls the highest number goes first; play then proceeds, in turn, to that detective's left.
  - 6) Press the ON button twice and you'll hear a thief committing a crime. Look at the display to see the number of the building or street where the crime is taking place.

# PLAYING

**BEFORE YOU PLAY, PLEASE READ ALL OF THE FOLLOWING INFORMATION VERY CAREFULLY.**

## ON YOUR TURN:

- 1) Press the CLUE button *once*. Listen for a sound clue and watch the Display.
- 2) Roll the dice.
- 3) Based on the sound clue you just heard—and any others that preceded it—move your playing piece. Move it, according to your roll, toward where you think the thief is on the board.
- 4) If you can, try to make an arrest.

**SLEUTH CARDS.** At any time during your turn—either before or after rolling the dice—you may, if you wish, play one of your Sleuth Cards. You may play whichever one you wish, but may play *only one* card on a turn. As soon as you've played a card, return it, face down, to the bottom of the draw pile. Then *replace it* with the draw pile's top card.

## How a Thief Moves

A thief moves only in certain ways. By knowing how he moves, you can track him more easily and try to arrest him more quickly.

- a) There are only two times when a thief will move. He *usually* moves when a detective presses CLUE. He *always* moves to escape from the cops after an unsuccessful arrest.
- b) A thief might move in any direction—horizontally, vertically or diagonally. But he will move only *two* board spaces at a time and only from one *numbered* space to another.

1.

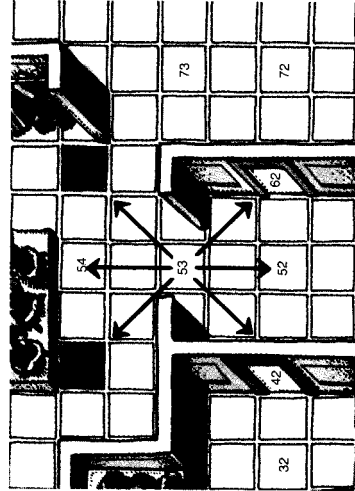

From space #53, the thief might move to any of these numbered spaces.

- c) A thief will not immediately return to the numbered space he has just left.

2.

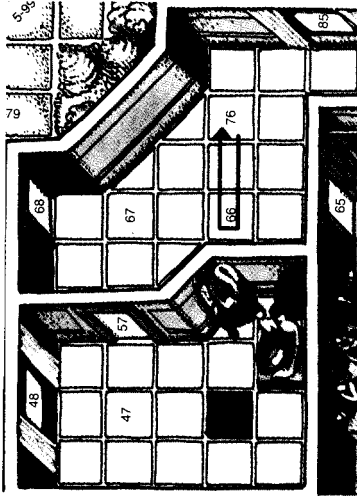

He will never do this in 2 moves.

3.

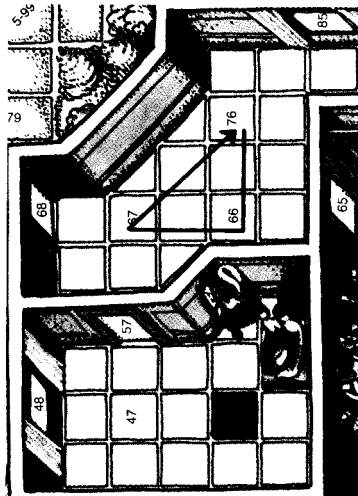

He might do this in 3 moves.

d) A thief sometimes moves diagonally to a door or window, or through one.

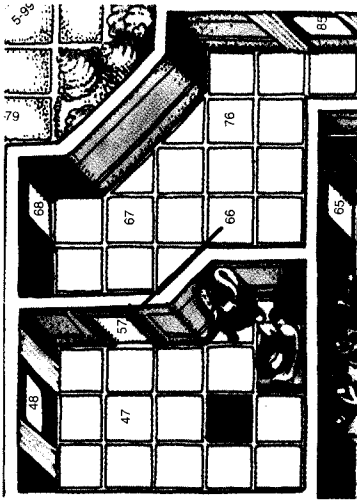

4.

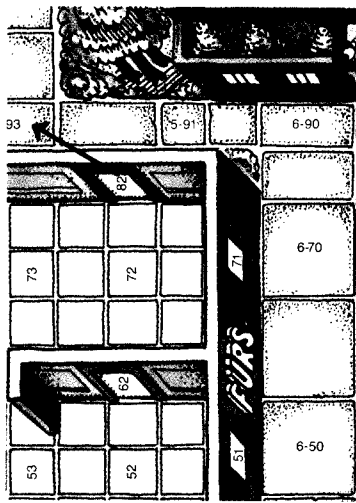

5.

Look closely at these tricky thief moves.

e) Whenever a thief opens a door or breaks a window, he will go *through* that door or window the *next time* he moves.

f) A thief will not climb over a wall.

g) When a thief is *in a building*, he will *always* grab at the chance to commit a crime. Whenever he's only one move away from a possible indoor crime location, he will commit that crime the *next time* he moves.

h) After a thief commits a crime in a building, that particular crime location will register (on your ELECTRONIC CRIME SCANNER) as a FLOOR space *until the thief leaves that building*. After all, no item can be stolen twice; it has to be replaced by its owner—the jeweler, antique dealer, etc.

In large cities, outdoor businesses are easy targets for crime. Therefore, if a thief robs the NEWSSTAND, it will close down and register as a STREET space *until that thief is arrested*. Only a new thief will be able to rob it again.

i) Every thief knows the advantages of escaping on the subway. Whenever a thief reaches the numbered space in front of a corner subway station, he will enter that station and ride on the subway the *next time* he moves.

j) After riding the subway, a thief may resurface at any of the five subway stations—perhaps even at the one he just entered. No matter where he resurfaces, however, he will always exit on the numbered space that's directly in front of a station.

k) If a thief escapes from the cops, he won't stop moving until he has moved *either 5 or 6 numbered spaces* away from them. So listen carefully for the sequence of five or six sound clues after an *unsuccessful* arrest.

### Tracking a Thief

Tracking a thief is a process of deduction that requires logic and common sense. As you know, at any given moment the thief might be at any one of several different locations. To determine his possible *current* locations, you must keep in mind his possible *previous* locations. In other words, *where he might be now depends on where he might just have been*.

The following sequence of sound clues will help to explain tracking. In the illustrations, the *circled* spaces represent the thief's *possible current* locations. The arrows are color-coded to show how he might have arrived at each of these locations. Don't try to follow all the arrows in an illustration at once. You'll find it easier to follow the

arrows of each particular color from one illustration to the next.

**In this example, the sound clues and Display readout are only imaginary; so do not use your ELECTRONIC CRIME SCANNER. In a regular game, each detective, in turn, uses the CRIME SCANNER unit to get a sound clue, while all the other detectives also listen.**

a) **1st SOUND CLUE: a CRIME ALARM.** Building 1 appears on the Display. At this moment, the thief must be at one of the four possible crime locations in this building. (Figure 6)

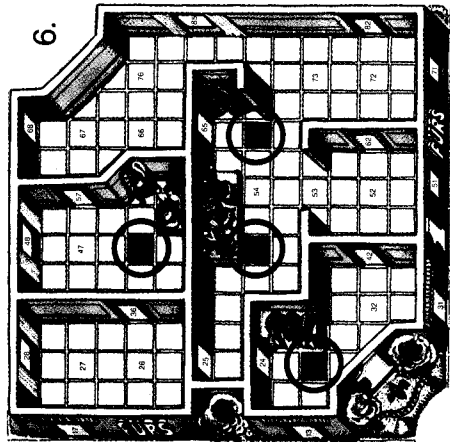

6.



b) **2nd SOUND CLUE:** the thief opens a DOOR. Look for every DOOR that lies exactly two spaces away from a possible crime location. (Figure 7)

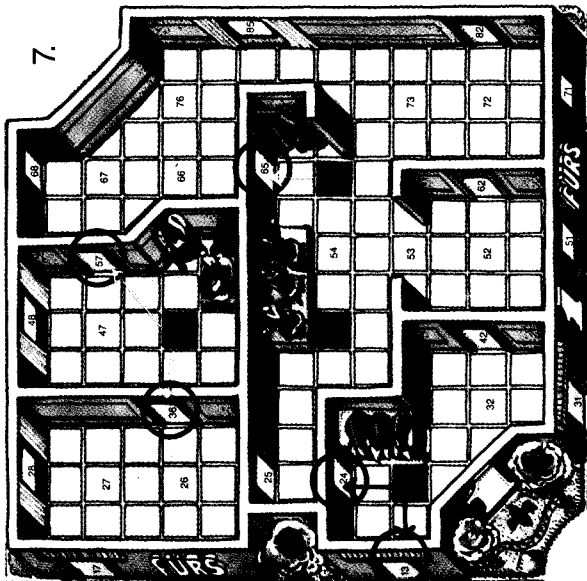

c) **3rd SOUND CLUE:** the thief walks across the FLOOR. Look for every FLOOR space that lies exactly two spaces away from a DOOR where he might just have been. (Figure 8)

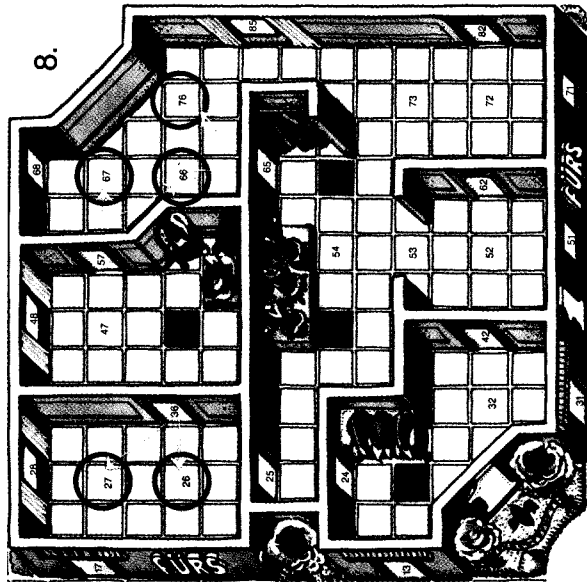

Notice in Figure 8 that FLOOR spaces 47 and 54 are not among his possible current locations. Why? Because a thief always goes *through* a DOOR that he opens.

d) **4th SOUND CLUE:** the thief opens another DOOR. Look for every DOOR that lies exactly two spaces away from the FLOOR spaces where he might just have moved from. (Figure 9)

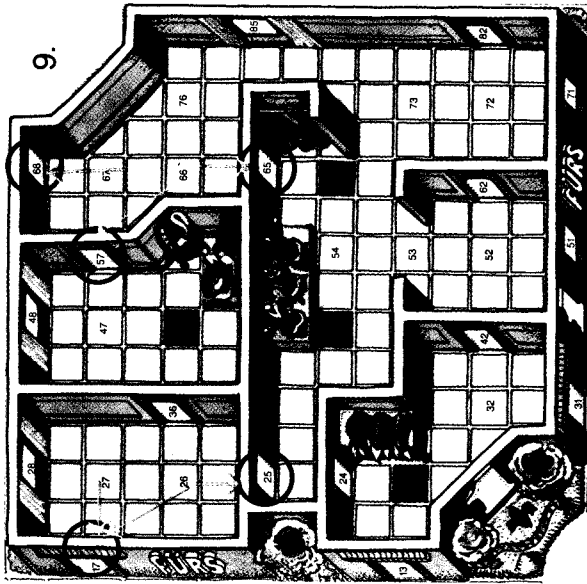

Notice in Figure 9 that DOOR 36 is not among his possible current locations. A thief will not immediately return to a space where he might just have moved from.

e) **5th SOUND CLUE:** the thief breaks a WINDOW. As you can see, there's only one WINDOW that lies exactly two spaces away from his previous possible DOOR locations. (Figure 10)

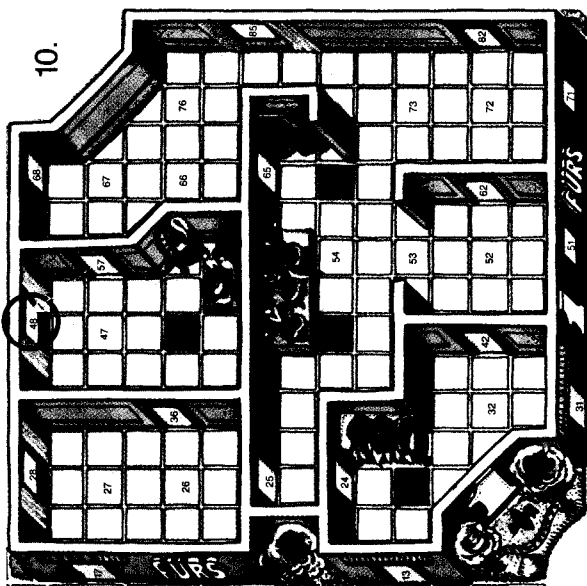
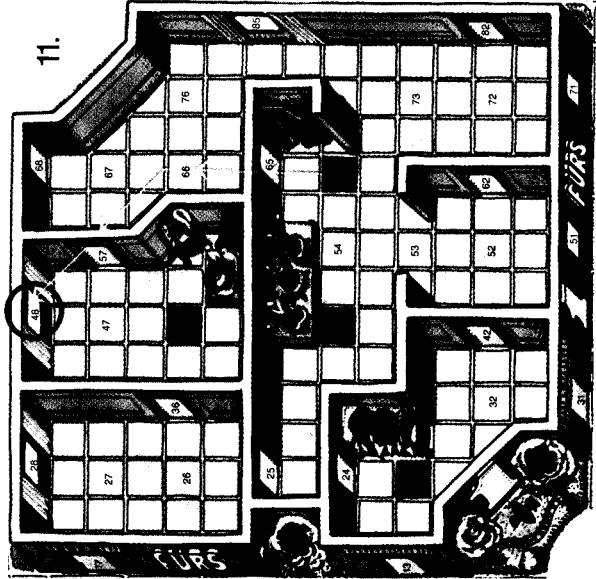



Figure 11 shows the thief's actual route—starting at the scene of the crime.



Now that you know exactly where he is, will you be able to move in close enough to try an arrest?

### How a Detective Moves

As you know, a thief moves only from one *numbered* space to another. A detective, however, moves on *every* space—whether it's numbered or not.

- You may move in any direction (horizontally, vertically or diagonally) and may, on a single turn, change directions as often as you wish.
- You do not have to move the full count of your roll. *Example:* If you roll a 7, you may move as many as 7 spaces or as few as 0.
- If your roll would land you *by exact count* on a space that's already occupied by another detective, move immediately to any space that's *directly next* to the space you would have landed on.
- Like a thief, you can move through a door, but *not* over a wall.
- Even though a thief can move through a window, you can *not*.
- If you *start* your turn on a subway station, you may—either before or after rolling—move to any other station. You may then move from the new station up to the limit of your roll.

If you *end* your move on a subway station, you may immediately move to any other station.

You may *not*, however, *split* your move between subway stations. *Example:* Let's say that you roll a 6 and, after moving 3 spaces, enter a subway station. You may, if you wish, move to any other subway station. But if you do, you *must* stop moving there; you may not move the remaining 3 spaces of your roll.

### Arresting a Thief

You may try an arrest if you're *on* or *directly next* to the thief's exact location; or if you're on or *directly next* to where you *think* his exact location is.

To try an arrest, first press ARREST to notify the cops. Then use the numbered buttons to direct the cops to the thief.

If the thief is hiding in a *building*, first press the ARREST button; then press the building's number; then press the two numbers that show his exact location in that building. (In the previous example—under **Tracking a Thief**—you would press: ARREST - 1 - 4 - 8.)

If the thief is *on the street*, first press ARREST;

then press the *three* numbers that show his exact location on the street.

- If your arrest is *successful*, take the WANTED Poster and all the Reward Money that goes with it.
- If your arrest is *unsuccessful*, listen carefully for the séquence of five or six sound clues as the thief escapes from the cops.

c) In the example under **Tracking a Thief**, you learn *exactly* where the thief is hiding (Building 1, Window 48). Therefore, if you were able to try an arrest, you'd know that you were sending the cops to the correct location. Sometimes, however, you only *think* you know where the thief is hiding; or you might even want to take a wild guess. In either case, if you send the cops to the wrong location, you're guilty of a *false arrest*.

When this happens, you immediately lose your Detective License. First turn it over and end your turn. Then, on your *next turn*, get your License back by paying the Bank a \$100 fine. (If you have only \$50, pay that. If you have no money at all, you don't have to pay anything.) As soon as you get your License back, your turn ends.

**Remember: When a thief first commits a crime, he's worth the face value on his WANTED Poster. However, if you or your opponents fail to arrest this thief before he robs again, the Banker adds \$100 to the Reward Money for each additional crime.**

### **A New Thief**

After a successful arrest, each detective leaves his or her playing piece where it is on the board. The detective who made the arrest turns over the top WANTED Poster and covers it with the appropriate amount of Reward Money from the Bank. He or she then presses the ON button *once*, thus causing this new thief to commit a crime. The player to that detective's left now takes his or her regular turn.

## **WINNING**

The winner is the first detective to earn \$2,500 in Reward Money.

## **SPECIAL NOTES**

### **1) SOUND CLUES**

- a) Be sure to listen to your opponents' sound clues as well as to your own. The more sound clues you hear, the easier you'll find it to track the thief.
- b) Your ELECTRONIC CRIME SCANNER can remember the last 10 sound clues. If you forget the most recent sound clue, press 0 and you'll hear it again. Then, if you want to hear the sound clue before that, press 1. For the sound clue before that, press 2, etc. You will not hear the "bleeps" that represent the times when the thief didn't move.

**Because of this special memory feature on your CRIME SCANNER, you do not have to write down the clues that you hear.**

### **2) REWARD MONEY**

The \$300 that you receive at the start of the game is considered an advance toward the \$2,500 that you need in order to win. Therefore, when you earn Reward Money, add it to whatever money you already have.

### **3) ARRESTING A THIEF**

As you know, to arrest a thief you must first press ARREST; you must then press the three numbered buttons that show his exact location on the board (or at least where you *think* his exact location is).

It may happen that you start to arrest a thief but—for one reason or another—change your mind. If you change your mind *before you've pressed the third numbered button*, you can stop the arrest by pressing the ARREST button again. At this point you may either continue playing as usual or—by pressing ARREST once more—try to arrest the thief.

## 180-DAY LIMITED WARRANTY

PARKER BROTHERS warrants, subject to the conditions below, that if the components of this product prove defective because of improper workmanship or material during the period of 180 days from the date of original purchase, PARKER BROTHERS will repair the product or replace it with a new or repaired unit, without charge, or will refund the purchase price.

### CONDITIONS:

1. Proof of Purchase: The retail sales receipt or other proof of purchase must be provided.

2. Proper Delivery: The product must be shipped, prepaid, or delivered to PARKER BROTHERS (address: 190 Bridge Street, Salem, MA 01970, Attention: Quality Control Dept.) for servicing, either in the original package or in a similar package providing an equal degree of protection.

3. Unauthorized Repair, Abuse, etc.: The product must not have been previously altered, repaired or serviced by anyone other than PARKER BROTHERS; the product must not have been subjected to an accident, misuse or abuse.

EXCEPT TO THE EXTENT PROHIBITED BY APPLICABLE LAW, ALL IMPLIED WARRANTIES MADE BY PARKER BROTHERS IN CONNECTION WITH THE PRODUCT, INCLUDING THE WARRANTY OF MERCHANTABILITY, ARE LIMITED IN DURATION TO A PERIOD OF 180 DAYS FROM THE DATE OF ORIGINAL PURCHASE; AND NO WARRANTIES, WHETHER EXPRESSED OR IMPLIED, INCLUDING THE WARRANTY OF MERCHANTABILITY, SHALL APPLY TO THIS PRODUCT AFTER SAID PERIOD. SHOULD THIS PRODUCT PROVE DEFECTIVE IN WORKMANSHIP AND MATERIAL, THE CONSUMER'S SOLE REMEDY SHALL BE SUCH REPAIR, REPLACEMENT OR REFUND AS IS HEREIN ABOVE EXPRESSLY PROVIDED; AND UNDER NO CIRCUMSTANCES SHALL PARKER BROTHERS BE LIABLE FOR ANY LOSS OR DAMAGE, DIRECT OR CONSEQUENTIAL, ARISING OUT OF THE USE OF, OR INABILITY TO USE, THIS PRODUCT.

SOME STATES DO NOT ALLOW LIMITATIONS ON HOW LONG AN IMPLIED WARRANTY LASTS, OR THE EXCLUSIONS OR LIMITATIONS OF INCIDENTAL OR CONSEQUENTIAL DAMAGES, SO THE ABOVE LIMITATIONS OR EXCLUSION MAY NOT APPLY TO YOU. THIS WARRANTY GIVES YOU SPECIFIC LEGAL RIGHTS AND YOU MAY ALSO HAVE OTHER RIGHTS WHICH VARY FROM STATE TO STATE.